

The "MIDLINE"  
Condenser

Gives better separation of wavelengths than previous types. Its full-floating rotor with removable shaft, easily adapts it to any scheme of single-control, multiple condenser operation.



"HAMMARLUND  
JR"

A high-ratio, shielded midsize condenser for use wherever small variable capacities and fine tuning are required. Baseboard or one-hole panel mounting. Knob included.



Slide-Assembled  
ALUMINUM SHIELD

Strong, neat, quickly and easily assembled. Designed to enclose complete tuning unit, tube and socket. An efficient aid to selective tuning. Greatly improves tonal quality.



**Build Your Own Masterpiece!**  
Give your radio without excitation, without expense a radio receiver as different as anything ever constructed. And give your radio the same quality that you find in the finest radio sets. This is the only Hi-Q receiver that gives you the most important new feature. And the giving of the most important new feature. And the giving of the most important new feature. And the giving of the most important new feature.

**Hammarlund  
HiQ**

## Mr. Designer—

No one knows better than you the importance of good parts—

**B**UILD your new 1927-1928 receiver or construction kit around the Hammarlund Condensers, Coils, Equalizers and Shields pictured and described on this page.

Hammarlund's world-wide reputation for precision accuracy is added to your own prestige when you use Hammarlund standard parts or when Hammarlund builds to your individual specifications.

*With a good start the race is half won.*

Hammarlund's designing department is yours to command—NOW, while the season is still young.

HAMMARLUND MFG. CO.  
424-438 W. 33rd Street, New York City

For Better Radio  
**Hammarlund**  
PRECISION  
PRODUCTS



The "AUTO-COUPLE"

A scientifically correct assembly of Spacewound Coil and "Midline" Condenser. The primary coupling is automatically varied at each condenser setting. Coil and condenser sold separately.



EQUALIZER

A compact, efficient variable condenser of small capacity, for neutralizing against undesirable oscillations or equalizing the capacities of multi-tuned circuits.



H-R "Hi-Q"  
Foundation Unit

Contains Micarta drilled front panel, sub-panel, shields, equalizers, resistance, extension shaft, wire, solder, nuts, screws and all special accessories for building the Hammarlund-Roberts "Hi-Q" Resolver.

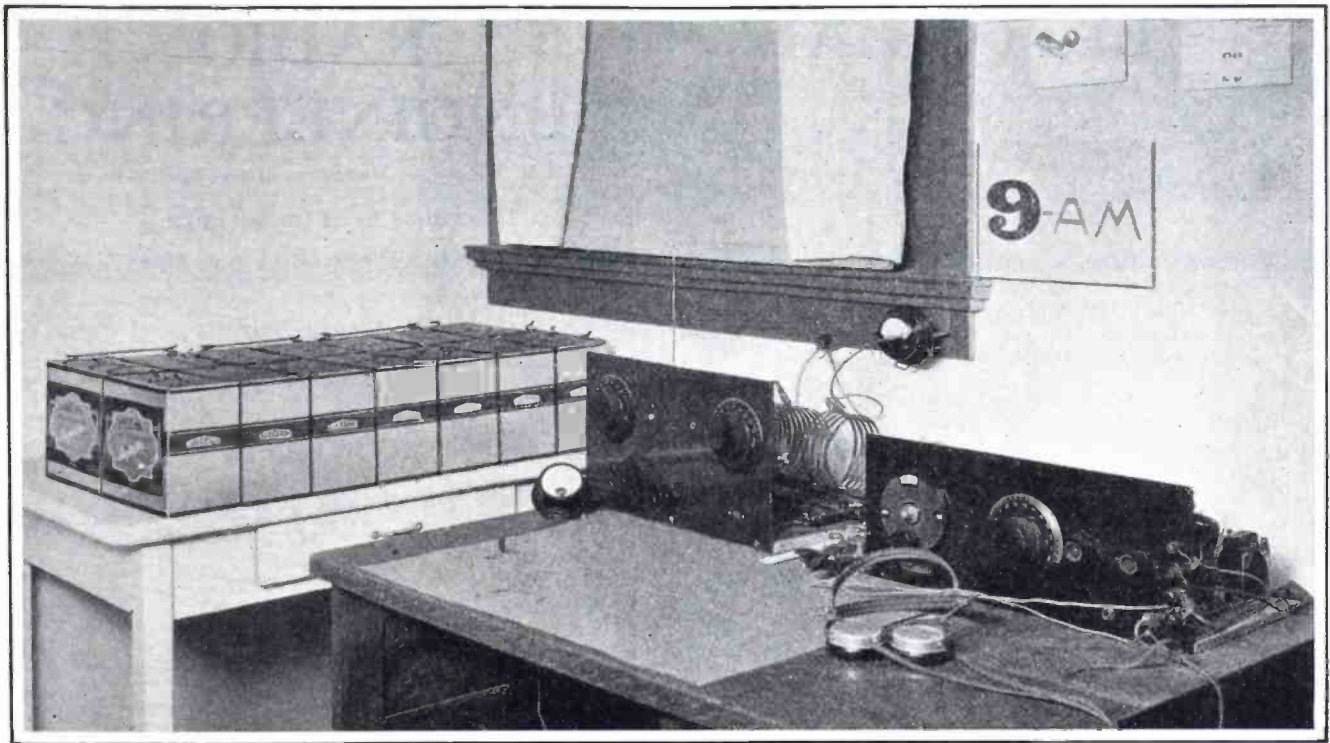

## You'll handle more traffic on pure DC

STATION 9AM, owned and operated by J. L. Adams, Glencoe, Illinois, represents simplicity and efficiency from the ground up (HI).

The transmitter is the familiar inductive coupled Hartley. A Pyrex socket holds a UX-210; the plate current supply is from a bank of fourteen Eveready Layerbilt "B" Batteries, delivering 630 volts of pure DC.

Shortly after the transmitter was completed, tests were carried on in the heart of Chicago using a thirty-foot horizontal antenna, strung through an apartment building, using a radiator for ground.

During these tests nearly all reports from the East, as far as New Hampshire, were R7 and R8. Stations on both coasts and North were worked during these tests. Southern stations, however, were nil.

This work was carried on in the middle of summer under all weather conditions. Some of the best contacts and best DX were accomplished during heavy electrical storms. The percentage of contacts ran astonishingly high during these indoor tests. As a result of these experiments and later ones, 9AM has become a confirmed believer in dry cell "B" batteries for low-power transmitters. Witness the

bank of Eveready Layerbilts on the table in the photograph.

The success of these tests was undoubtedly due to two things in the main—the pure DC plate supply and the simplicity of the Hartley Circuit. The transmitting amateur will almost invariably stop on a pure DC note, because of its readability, its ability to penetrate heavy QRM and QRN and its pleasing tone.

Inasmuch as this layout is located in a kitchen, pure DC plate supply is absolutely necessary to keep that frying noise out of the emitted note (HI HI).

Eveready Layerbilt "B" Battery No. 486, 45 volts, is being chosen by a steadily increasing number of BCL's as well as amateurs. We know of no battery that gives longer service.

*Manufactured and guaranteed by*

NATIONAL CARBON COMPANY, INC.

New York

San Francisco

Canadian National Carbon Co., Limited, Toronto, Ontario

Tuesday night is Eveready Hour Night—9 P. M., Eastern Standard Time, through the WEAf network stations

**EVEREADY**  
**Radio Batteries**  
*-they last longer*

# EDITORIAL

PREPARATIONS for activities which will commence at the R.M.A. show in June have been given a tremendous impetus by the passage of the Dill Bill, and the admirable selection made by President Coolidge for the members of the commission created under the new laws.

Certainly the industry can expect an intelligent interpretation of the regulations, far removed from the bias of political expediency. It is possible, of course, that objections will be raised to these nominations, but their confirmation is practically assured.

For administrative purposes, the United States have been divided into five districts. Orestes H. Caldwell, of Bronxville, N. Y., has been selected to represent the first district, comprising the New England States, New York, New Jersey, Delaware, and Maryland. Mr. Caldwell, youngest member of the commission, is 39 years of age. A graduate of Purdue, his career has been largely editorial. In this capacity, he had edited radio and electrical journals, succeeding Dr. de Forest on the Western Electrician. He has been nominated for a term of five years.

Certainly we shall be glad to see William H. G. Bullard, Rear Admiral, retired, of Media, Pa., serving for six years as chairman, and representative of the second district. His age has not been given, but his retirement from the U. S. Navy in no way indicates a conclusion of his brilliant service, particularly in connection with naval communications. He will represent Michigan, Pennsylvania, Ohio, Kentucky, and the Virginias.

The third district, bounded on the west and north by Texas, Oklahoma, Arkansas, Tennessee, and North Carolina, will be represented by Eugene O. Sykes, 51, of Jackson, Miss. Serving for four years, he will provide a background of judicial experience, for he is an attorney by profession, and is a former Justice of the Supreme Court of Mississippi.

Henry A. Bellows, of Minneapolis, representing the fourth district for three years, is known to mid-western B.C.L.'s as director of station WCCO. Mr. Bellows is 42, a graduate of Harvard University, and a former instructor there. During the war, he was a Colonel in the Fourth Minnesota Regiment. His district includes Wisconsin, Illinois, Missouri, Iowa, Kansas, Nebraska, the Dakotas, and Minnesota.

John E. Dillon, 61, of Los Angeles, is known to radio men as a Radio Supervisor of the Department of Commerce. The fifth district, which he will represent for two years, is bounded on the east by Montana, Wyoming, Colorado, and New Mexico.

Now, with ample time for fall preparations, the manufacturers can proceed with reasonable confidence in the stimulation of public interest in broadcast reception, not only because new B.C.L.'s will find air conditions improved but because they will expect them to be. The passage of this legislation will tend to make the uninitiated feel that propitious time has come at last.

And what is of great importance to present set owners is the stimulus given to program-development at stations continuing on the air, for the directors can count upon reception commensurate with the quality of transmission.

Why not promote the slogan—"Get a new set for the new broadcasting"?

M. B. SLEEPER, *Editor.*

# RADIO ENGINEERING

The Technical Magazine of the Radio Trade

Edited by M. B. SLEEPER

Managing Editor, HOLLIS de NEEFE

Vol. VII.

MARCH 1927

No. 3

Seventh Year of Publication

## CONTENTS

Industrial Gas a Factor in Radio Manufacture .....	609
<i>By J. B. Nealey</i>	
Harmonic Generation .....	611
<i>By Hoy J. Walls</i>	
Special Detector Tubes .....	612
<i>By H. A. Brown and C. T. Knipp</i>	
Motorboating Cured .....	614
<i>By Zeh Bouck</i>	
11 Tubes for Power Plus .....	615
<i>By Hollis De Neefe</i>	
The Glo-liminator .....	617
<i>By H. F. Van Holm</i>	
Packing Radio Parts .....	619
<i>By Tiff</i>	
Tuned R. F. Coil Design .....	620
A Socket Power Super .....	623
Super-Power Rectifiers .....	625
The Dill Bill .....	625
Directory of Equipment and Apparatus .....	644
Advertiser's Index .....	646

## In the April Issue

The application of series filaments to a tuned R. F. receiver and arrangements for obtaining the maximum efficiency from this wiring will be fully described in the April issue.

## RADIO ENGINEERING

Published monthly by RADIO ENGINEERING MAGAZINE, Inc. Publication office, Lyon Block, Albany, New York. Editorial and General office, Radio Hill, Poughkeepsie, N. Y. Printed in U. S. A. Yearly subscription \$2.00 in U. S. and Canada; ten shillings in foreign countries. Entered as second class matter at the postoffice at Albany, New York, January 9, 1925, under the act of March 3, 1879. New York advertising office, B. S. Davis, 52 Vanderbilt Ave. Chicago advertising office, E. H. Moran, 307 N. Michigan Ave.

Radio Set Manufacturers will find here better values, in performance and reliability, than any similar parts they have considered!

# MODERN TRANSFORMERS and "B" ELIMINATORS

A comparative test of any item in the MODERN line will readily establish the fact that it offers maximum value consistent with price. This applies both to parts designed to meet a price and also those designed to give perfect results.

The output of the MODERN plant is limited to assure absolute uniform quality. We recommend prompt action if you wish to consider these exceptional units.



Type A—A shielded transformer of unusual efficiency, designed to meet the demand for a low priced unit of satisfactory performance. Made in 3½ to 1, and 6 to 1 ratios.



Type D—A shielded transformer made in 3½ to 1 and 6 to 1 ratios for the manufacturer who requires a moderate priced unit of better than average performance.

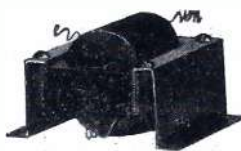

Type G—An unshielded transformer of the same winding and performance as Type D. Supplied in a variety of mountings.

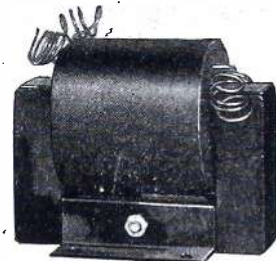

Type J—A highly perfected transformer made in 2 to 1, 3 to 1 and 4 to 1 ratios, for the manufacturer who demands the finest performance with reasonable price. Available with various mounting brackets.



Type M—We unqualifyingly pronounce this the finest audio transformer yet produced. The manufacturer striving to build the most perfect set possible is missing a big bet if he fails to test out his set using these transformers. 1st stage 3 to 1 Ratio,

2nd stage 4 to 1, output 1 to 1. A response curve of the Type M Modern shows the same amplification at 30 cycles as at 3000 cycles, with a reduced amplification above 6400 cycles, so that while the ordinary transformer over amplifies the high harmonics thus causing a hiss the Type M eliminates this undesirable reaction.

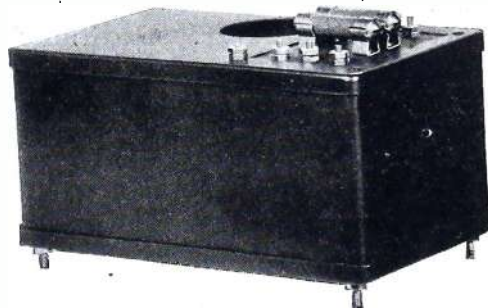

## Modern "B" Eliminators

Modern "B" Battery eliminators are available for the set manufacturer in both the Raytheon and emission types, in the same high quality that made MODERN COMPACTS so efficient during the past season.

It is noteworthy that Modern "B" Compact went through the year with practically no returns or complaints.

As supplied to manufacturers Modern eliminators are equipped with fixed resistances to meet the current requirement of the set, with no adjustment necessary by the operator.

*Tell us your requirements. It will be to your profit.*

**The Modern Electric Manufacturing Co.**  
Toledo, Ohio.



# The Coils the thing!

that  
makes  
Radio

No Radio Unit is any better than its coils---true of all electrical apparatus where coils are used, but most true of Radio.



**E**VERY step of Radio progress calls for more and better coils. The strong trend this year toward "B" power units, "A" battery chargers and other devices to use light socket power, makes the coil of greater importance than ever. Ordinary coils produce only ordinary quality of reception and make a mediocre out of an otherwise fine set.

It is therefore important for radio manufacturers to buy the *best coils* wound from the *best magnet wire*.

It is equally important for every jobber and dealer to *know* what kind of coils are used in every radio unit he sells to his customers. In other words,

*Good Coils Make Good Radio Units*

# DUDLO

**DUDLO MANUFACTURING CORPORATION, FORT WAYNE, INDIANA**

412 Chamber of Commerce Bldg.  
NEWARK, N. J.

160 North-La Salle Street  
CHICAGO, ILL.

4153 Bingham Ave.  
ST. LOUIS MO.

274 Brannan St.  
SAN FRANCISCO, CALIFORNIA

# Proven Efficiency

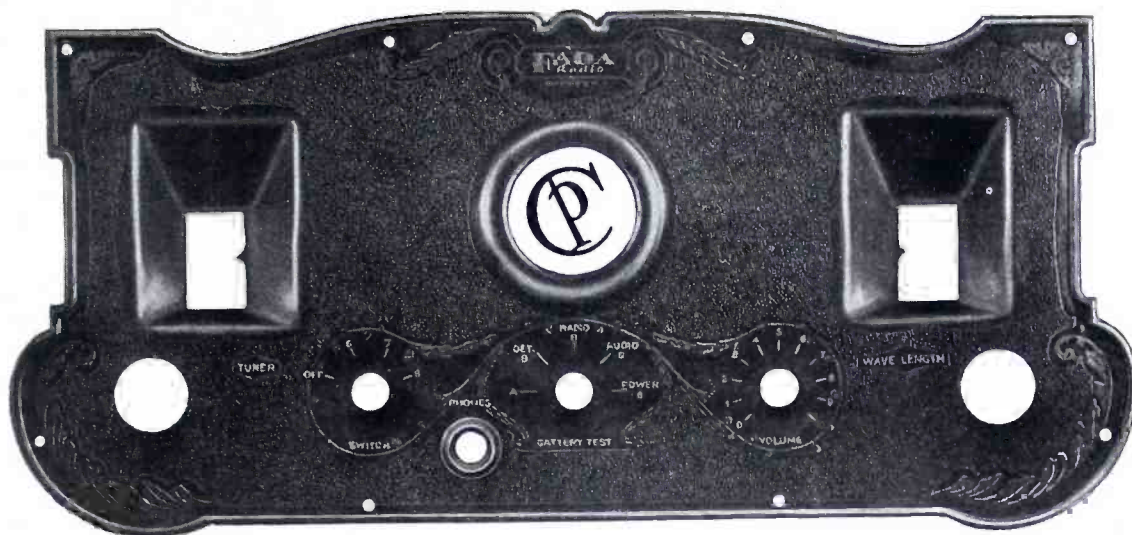

## Crowe Metal Panels

"There's a reason"—many reasons, in fact, why scores of representative set makers adopted Crowe metal panels and escutcheon plates on last season's output. These reasons apply with equal force to your requirements this season, and affect such vital problems as manufacturing cost, convenient assembly, efficient reception.

**NOW**

is the time to learn the facts, before you are committed to less efficient methods and mediums. Our representative will be on the job with samples if you require them.

*We Make Steel Panels, Too*



**CROWE NAME PLATE & MFG. CO.**

**1749 Grace St.**

**Chicago**

# INSULATION THAT PROTECTS

The function of insulation is to safeguard the circuit against any possible leaks or losses that might impair the volume or quality of the current on its way through the apparatus.

Poor insulating materials are questionable economy. Yet in many cases the best material is not necessarily more expensive.

Hard rubber, when specially compounded for radio service, has the most desirable dielectric characteristics of all available substances. And its mechanical advantages are quite as important too.

Being a plastic compound it is readily moulded and vulcanized to whatever form is desired and in its hard state it may be drilled, threaded and machined almost like a metal.

Almost every manufacturer of radio parts and apparatus needs dependable insulation. To such manufacturers the facilities of our large organization are offered in a spirit of helpful co-operation and intelligent understanding.

May we be of service to you?

**AMERICAN HARD RUBBER COMPANY**  
11 Mercer Street  
New York, N. Y.

*World's largest manufacturers of Hard Rubber and its products.*

# ENDORSEMENT

"The tuning characteristics of this receiver are remarkable,—is approached by no other tuned radio frequency system."—**CHICAGO DAILY NEWS.**

"The Equamatic System can instantly be adjusted by hand without tools to meet the variable range of coupling and variable acceleration of coupling essential to the correct operation of any tuned radio frequency circuit, and may be used with remarkable advantage in any of the well-known hookups."—**NEW YORK SUN.**

"In the Equamatic you have without question what is the most highly efficient radio frequency circuit ever devised."—**NEW YORK TELEGRAM.**

"It is one of the outstanding developments of the year and bids fair to enjoy the popularity accorded the various Neutrodyne circuits of two and three years ago."—**CITIZENS RADIO CALL BOOK.**

"In comparison with a standard neutralized, five-tube tuned radio—The Equamatic receiver shows a distinct superiority."—**RADIO BROADCAST.**

"The Equamatic method of synchronizing the degree of coupling with the tuning is an important advance in radio design."—**RADIO MECHANICS.**

**T**HE EQUAMATIC SYSTEM is replacing the present "losser" methods of control. The public is beginning to recognize the superiority of radio receivers embodying the Equamatic System and an ever-increasing demand is assured. Licenses for the rights to use the Equamatic System in the manufacture of sets and kits are being issued to a limited number of established radio manufacturers.

*Before formulating plans for future production, investigate the exclusive advantages of the Equamatic System. Demonstration and tests may now be arranged by appointment.*

"Ingenious mechanical device—Revolutionary advance in coil design—Invention affords degrees of coupling exactly consistent with the frequency."—**RADIO WORLD.**

"The beauty of this system is that you are enabled to take full advantage of the amplification factor of your tubes."—**RADIO LISTENERS GUIDE AND CALL BOOK.**

"The Equamatic System is entirely automatic—can be applied to any circuit to give full efficiency over the entire wavelength range."—**RADIO ENGINEERING.**

"It is so fundamentally sound,—it works a whole lot better than ordinary human beings expect today's receiver to work."—**RADIO DIGEST.**

"The sensitivity of the set remains constant at all frequencies, and oscillation troubles are entirely absent."—**RADIO.**

"We have examined and tested this system, and find that it possesses greater average amplification, selectivity, sensitivity, and freedom from distortion than those of the present leading types of commercial radio receivers, and, further, that these advantageous features are maintained equal in value at all frequencies within the full broadcasting range."—**ERROTU LABORATORIES, INC.**

**THE EQUAMATIC SYSTEM, 10 ARGYLE RD., BROOKLYN, N. Y.**

**U. S. and Foreign Patents Pending**

**EQUAMATIC SYSTEM**  
LICENSED UNDER  
KING PATENTS PENDING





New 32-Page Booklet Giving Information Usually Known Only To Expert Set Builders

# Just off the press!

Every radio set contains from one to a dozen fixed condensers. Do you know what they are for? Do you know how to test them to see whether they are working properly? Do you know that there is a way of changing the range of your tuning condensers?—of getting greater selectivity—of improving the tone? All through simple applications of fixed condensers.

The Dubilier Condenser Corporation is now supplying radio fans with a complete and authoritative explanation of the correct use of fixed condensers.

You have often envied the man who could look over your set and by inserting a small fixed condenser somewhere, greatly improve its tone and operation. Do this yourself. Perhaps some defect in reception that you have always thought could not be helped is due to an imperfect condenser.

This new booklet will also give you the most recent information on power amplifiers, filters and battery eliminators. Send 10 cents in stamps or coin for your copy.

# Dubilier

**CONDENSER AND RADIO CORPORATION**

4377 Bronx Blvd., New York, N. Y.

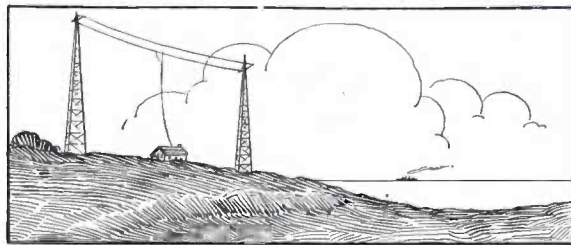

# INDUSTRIAL GAS AN IMPORTANT FACTOR IN RADIO MANUFACTURE

*A description of the manufacture of radio dry batteries and the importance of gas in this work—By J. B. Nealer*

**W**HILE the automobile rushed growth of the electric storage battery it was left to the radio to galvanize into activity the industry of making secondary power units in the form of B batteries. The complexity of the manufacture of this popular unit is exemplified at the plant of the National Carbon Company at Long Island City. The Eveready B battery of 45 volts is a nest of 30 small cells connected in series and sealed in a cardboard container with pitch and wax.

At the Eveready plant of the National Carbon Company a carefully worked out plan for the progressive movement of materials from one process to another, including gravity drops and mechanical conveyors, assures the maximum production with the minimum labor, time and space. The raw materials are stored on the fifth floor and it is here that the manufacture of the electrolyte paste and bobbin is started. In making the bobbins the mill is distributed by screw conveyor to chutes and dropped to the hoppers of six mixing machines on the floor below where it is mixed. A chemical solution is then piped to the mixing machines already containing the mill mixture, the whole agitated and the resulting product dropped through the floor into the hoppers of the tamping machines on the floor below.

## *Making the Bobbins*

Here are located tamping machines which tamp the mixture around

small carbon pencils or electrodes and thereby forming small cylindrical bodies called bobbins. The bobbins are then inspected, put on a traveling conveyor, run through a fine spray of water and carried to the cell assembly department, also on the third floor.

The electrolyte paste is mixed in two large tanks with agitators on the fifth floor, and the resulting product dropped into mixers on the floor below where flour and starch are added. This paste is then pumped into storage tanks in the cell assembly department on the third floor ready for use.

The small zinc cans are made in a department on the third floor in which are located automatic machines. These machines are fed with continuous strips of zinc metal of proper width delivered in rolls for convenience. The machines cut the strips into short lengths which are formed into cylinders on a roller. These zinc cylinders

are pushed along the roller and dipped into a pot of melted solder where the seam is soldered tight. This solder pot is kept hot by a gas burner. Round zinc disks are then forced into one end of the cylinder and the whole inserted on the spindle of a turret wheel which revolves and dips it into another pot of melted solder which solders the bottom and the finished can is then ejected. This pot is also fired with gas. Every action of these can machines, from the feeding of the zinc strip to the ejection of the finished can, is automatic.

## *Gas Pressure Raised*

The gas used in this plant comes in from the street main into the basement where four power driven boosters raise it from line to five pounds pressure. This high pressure gas is then distributed throughout the building in pipes for its convenient use in the different departments.

In the cell assembly department we find girls seated on both sides of an endless chain conveyor inserting the zinc cans into crossbars of conveyors, 10 to each crossbar. As the chain moves along the electrolyte paste is injected by an automatic paste filler. More girls then insert the bobbins, with star washers for centering and push them to the bottom of the can. The chain with the cans thus filled travels through heated water until the paste is cooked

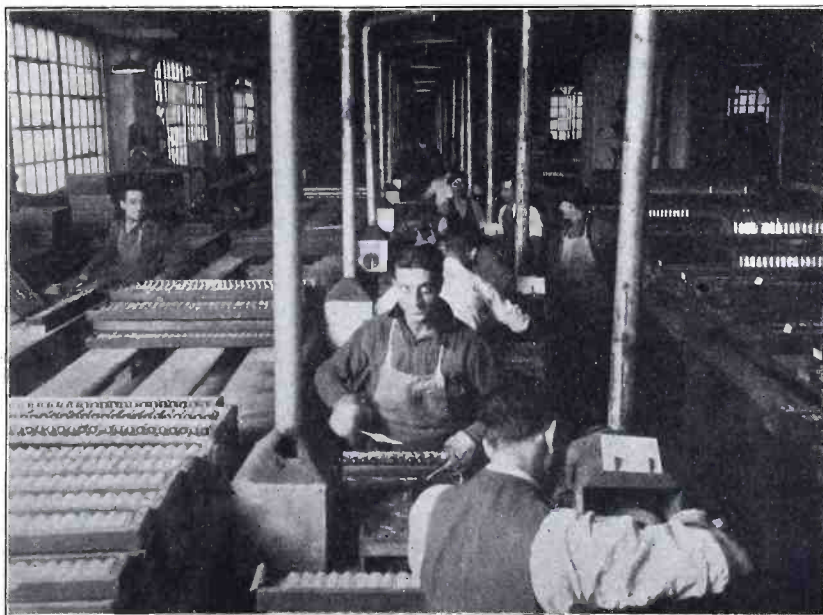

Gas ovens are used here to heat the irons with which connecting wires are soldered to the separate cells

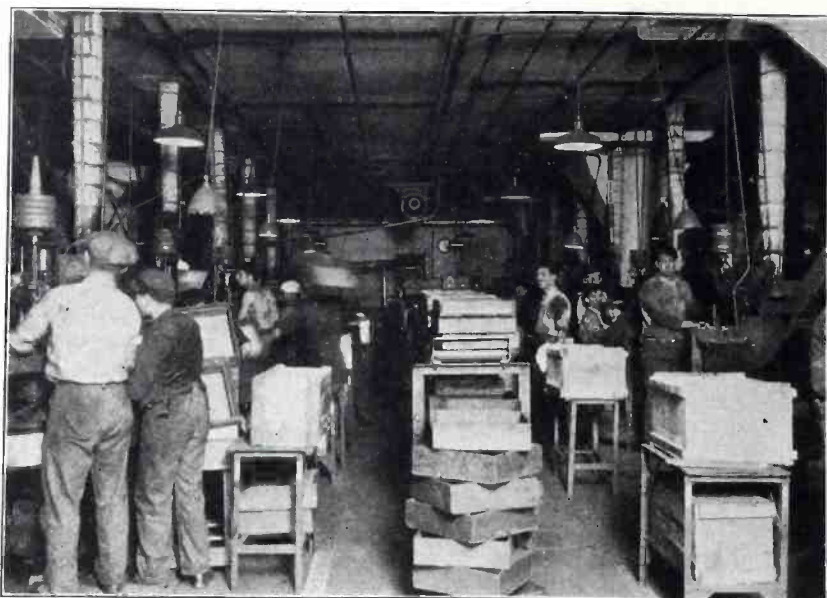

Shown here are the bobbin machines, which tamp the mill mix around the electrodes

or hardened. The cells are then removed and inspected. There are four of these endless chains, or assemblies. Conveyors then take the cells to automatic capping machines where a pasteboard washer is inserted and a brass cap forced onto the protruding end of the carbon electrode. The cells are then set into boxes in an upright position and conveyed to the sealing department where each one is sealed by pouring melted wax into the top, leaving the brass cap protruding.

After the finished cells have been stored for a period of from five to eight days they are taken out, tested for low voltage units and moved by conveyor to the battery assembling room which is on the second floor below. Here are long rows of gas-fired furnaces for keeping soldering irons hot while men solder on the connecting wires.



Above is an automatic machine which turns out zinc cans with soldered seams



the correct wire connections by men equipped with gas fired soldering irons. Gas is forced into small combustion chambers in the heads of these irons where it is burned with air, as in a Bunsen burner,—heating the copper point which melts the solder.

The conveyor then passes through crews who pour two coats of melted wax over the top of the battery and this wax is then cooled, as the batteries travel along, by electric fans. The batteries are then conveyed through gas-fired branding furnaces where the wax is softened and men stamp on the name Eveready, with hand dies, as they pass out through the discharge end. The final stage of the journey is from the gas-fired brand-

At the left the workmen are sealing the cells by pouring melted wax into the tops

ing furnaces to the packing room where the finished batteries are packed, stamped and stored for shipment.

### Box Making and Tube Winding

Incidental to the manufacture of the battery is the making of the cardboard boxes for the nests of cells and the winding of the cardboard cylinders for the cell jackets. Two automatic box machines are fed with cardboard and cut, fold and glue the boxes automatically. In winding the tubes two continuous strips of cardboard are run onto a revolving steel roller from different directions and at an angle of about 30 degrees each to the line of travel of the finished tube. Each strip is first automatically coated on one side with asphalt, melted in a gas-fired pot. The strips are wound onto the roller, one on top of the other and with the asphalted sides contacting. Thus is formed a substantial and continuous cardboard tube which is automatically cut into 34-inch lengths as it is spun out. The 34-inch tubes are

then put into revolving cutters which cut them into from 10 to 15 cell jackets at one operation.

While this article has been confined to the manufacture of 45 volt B batteries, smaller B batteries as well as C batteries are made in another part of the building with much the same equipment and using practically the same methods.

Enumerating the different uses of gas by the National Carbon Company at the Eveready plant, we find seven as follows:—lead pots on the zinc can machines, soldering furnaces for soldering the wire connections, wax tanks in the sealing department, pitch kettles in the pitching department, soldering irons for fastening on the clips, branding furnaces in the stamping department and asphalt pots in the cell jacket winding machines. The gas is boosted from line pressure to five pounds pressure by four power driven boosters in the basement and distributed throughout the building in pipes ready for use.

## Harmonic Generation

*Simultaneous production of a fundamental and a harmonic in a tube generator\*—by Hoy J. Walls<sup>1</sup>*

**M**ETHODS are available for the transmission and reception of two or more frequencies from a single antenna. The published methods, however, contemplate independent modulation of the several frequencies and require a separate generating tube for each frequency. The method here described involves only a single tube. The application immediately in view was the simultaneous transmission of several standard frequencies; other applications are pointed out below. The work, which was done under the direction of Dr. J. H. Dellinger, was part of the standard frequency transmission program of the Bureau of Standards. The reader should understand clearly that the method is one of multiplex frequency transmission but not of multiplex signal transmission, since there is only a single modulation.

The experiments were made in June, 1924, to determine if it were practicable to operate a radio transmitting set on two or more arbitrarily chosen frequencies simultaneously. The results obtained when operating on two entirely independent frequencies were not as satisfactory as desired, but very good results were obtained when operating on two frequencies, one of which was a harmonic of the other.

The circuit arrangement used is given in Fig. 1. It is similar to the usual "Hartley" circuit but has an ad-

ditional tuned circuit ( $L_2C_2$ ) in series with the main tuned circuit ( $L_1C_1$ ). The antenna circuit is similarly arranged ( $L_3C_3$ ). It was found that,

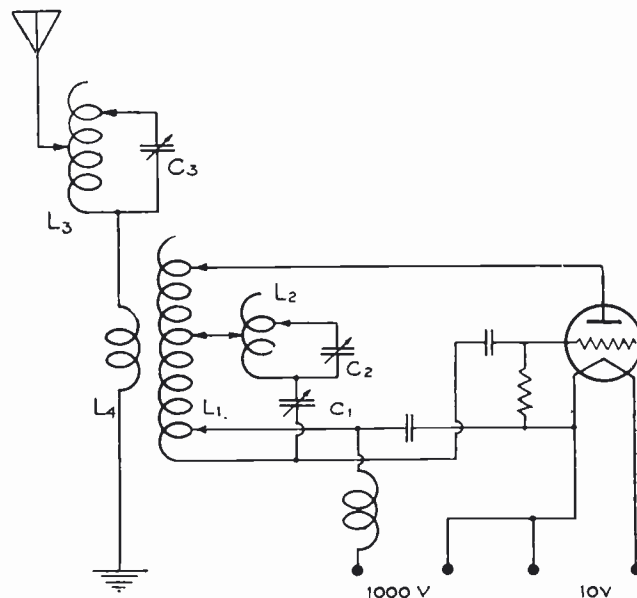

Figure 1—Arrangement for Producing Fundamental and One Harmonic.

when the tube was generating a frequency approximately  $f_1 \frac{1}{2\pi} \sqrt{L_1C_1}$  and the circuit  $L_2C_2$  were tuned to

some harmonic of  $f_1$  that harmonic  $hf_1$  would be materially amplified. The strength of the harmonic could be readily controlled by varying the coupling between  $L_1C_1$  and  $L_2C_2$ , this coupling being the portion of  $L_2$  common to both circuits. If the antenna, whose reactance has been adjusted so that it is zero for the two frequencies  $f_1$  and  $hf_1$ , is coupled to the inductance  $L_1$  both frequencies are radiated.

Such a tube arrangement, operating on a fundamental frequency of 600 kilocycles with the third harmonic (1800 kc.) strengthened, was coupled to an antenna tuned to 600 and 1800 kc. Good transmission of both frequencies was obtained over short distances. The transmission was not tried over long distances, since a low power tube was used while making the experiments.

Harmonics as high as the tenth (500 kc.) were strengthened with this arrangement when working with a fundamental of 500 kc. Higher harmonics could not be obtained in this case as the limit of the second oscillatory circuit used was slightly over 5000 kc. With a fundamental 2500 kc., harmonics as high as the fifth (12,500 kc.) have been amplified, which was the highest frequency to which the oscillatory circuit used could be tuned. Higher harmonics could probably have been obtained if the oscillatory circuit could have been tuned to higher frequencies. It is to be understood that only one harmonic was amplified at a time. There was no apparent increase in the strength of the other harmonics.

It is evident that the operation of

\* Published by permission of Director, Bureau of Standards.  
<sup>1</sup> Assistant Electrical Engineer, Bureau of Standards.

<sup>2</sup> See Bureau of Standards Circular No. 74, pp. 41 to 68.

then slightly increased harmonic voltage is fed back on the grid of the tube and is amplified, the strength to which the harmonic is amplified being dependent upon the coupling between the main circuit and the second LC circuit.

There are several important applications of this circuit arrangement. In relay broadcasting, the main station transmits the same program on two frequencies by means of two independent sets. One frequency is the regular operating frequency in the broadcasting band and the other a much higher frequency, usually between 2500 and 7500 kilocycles. With the circuit arrangement described here it would be quite possible to transmit two frequencies on the same set with any desired output within the capacity of the set on either frequency. This would result in considerable reduction in operating expenses as well as mak-

ing an additional transmitting set unnecessary.

In calibrating a wavemeter by the use of generator harmonics a generating set of this type is useful when the wavemeter indicator is not sufficiently sensitive to respond to the weak harmonics of the usual generating set. With a fundamental frequency within the range of the wavemeter, any harmonic or higher frequency can be simultaneously obtained with a strength sufficient to operate the wavemeter directly. By changing the fundamental frequency somewhat a new harmonic will be obtained and an indefinite number of points thus secured. To obtain lower frequencies the generating set is adjusted so that the harmonic amplified is within the range of the wavemeter and the fundamental will give the lower frequency.

carrying 0.7 to 1.0 ampere which will produce sufficient heat to make the tube walls fairly warm, say 40 deg. cent. on the outside. The tube is not stable in its action until the tube envelope gets hot, and this occurs in about one minute after the filament current is turned on. As soon as the tube begins to warm up the plate current rises, slowly at first, increasing its rate of increase as the tube gets warm; then ceases to rise, and finally decreases to a steady value when the tube walls have warmed up to the final temperature. This phenomenon is shown in Fig. 1. The response of the tube as a detector is rather peculiar and is also indicated on the curve sheet. The peculiar results shown in Fig. 1 do not obtain for any type of high-vacuum tube or gas-content tube now or formerly in general use. Whether or not the tube be well or poorly outgassed when the alloy is introduced, the results are the same in a general way. If there is considerable residual gas the variation is greater as the tube warms up than when the tube is well outgassed, however the writers have not been able to produce tubes which do not show this peculiar quality, and are therefore not able to say whether or not it is due to the presence of residual gas. While the plate current is increasing, a hissing sound occurs in telephone receivers placed in the plate circuit of the tube, the sound increasing in intensity to a maximum, then gradually reducing again until it is not heard when the plate current has reached its steady value. The more "gassy" the tubes the more intense is the hissing sound.

The cause of the variation in plate current detector performance has not been found. It is certain that as these qualities vary the vapor pressure of the alloy within the tubes is increasing until the tube walls reach a final temperature. The increasing vapor pressure in some way affects the behavior noted. The exact mechanism of this, is however not understood at present.

### Performance Characteristics

1. *Variation of Response with Plate Voltage, and Input Voltage.* When a high vacuum tube is used as a detector the optimum response will occur at low plate or anode battery potential when the input voltage is very small. When the input voltage is comparatively very large, producing an optimum response having a directly measured audibility of about 150 times, this optimum response occurs at the highest plate voltage that can be provided just below the point where residual gas atoms become ionized. This is usually about 80 to 100 volts for the small amplifier tube now in use. A soft detector tube will not respond at medium plate voltages at all, due to intense ionization. But potassium sodium alloy tubes respond to strong input or signal voltages with increasing intensity as the plate voltage is raised as do high vacuum tubes, even though these tubes contain con-

## Special Detector Tubes

*A study of the behavior of alkali vapor detector tubes—  
By Hugh A. Brown and Chas. T. Knipp\**

**S**INCE the original investigation of certain alkali vapor tubes used as detectors was completed, new and more sensitive types of tubes have been developed and put on the market. Interest has centered around the comparative efficacy of the later

(These unique features will probably be the ultimate basis for a scientific explanation of the physical phenomena occurring within tubes of this type.) The observations are confined to tungsten filament tubes into which the molecular alloy of potassium and sodium

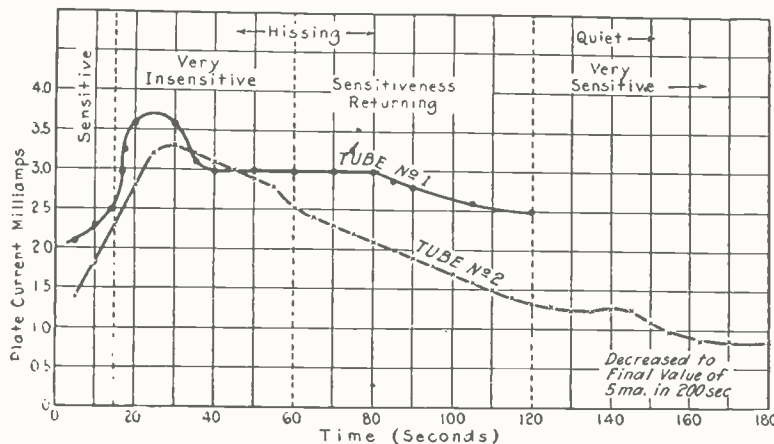

Figure 1

tubes with the supersensitive (potassium sodium alloy) tubes previously developed. It is the intention of this paper to point out not only the actual comparisons, but also the manner in which the comparative tests were made. In the past, erroneous interpretation of comparative results have often occurred, due to variations in the manner of conducting tests.

Some very peculiar and interesting features of behavior of the alkali tubes will also be described and illustrated.

has been distilled at a temperature of 250 deg. cent. by an oil bath. This particular treatment seems to yield finer results in detection than any other single alkali metal vapor content. A few observations were also made of the effect of forcing sodium through the glass walls, this latter treatment yielding no sensitive detection performance whatever.

### Transient Plate Current Variations

In order to produce a sensitive potassium sodium alloy content detector it is essential to use a tungsten filament

\*From a paper presented before the I. R. E. at the January meeting.

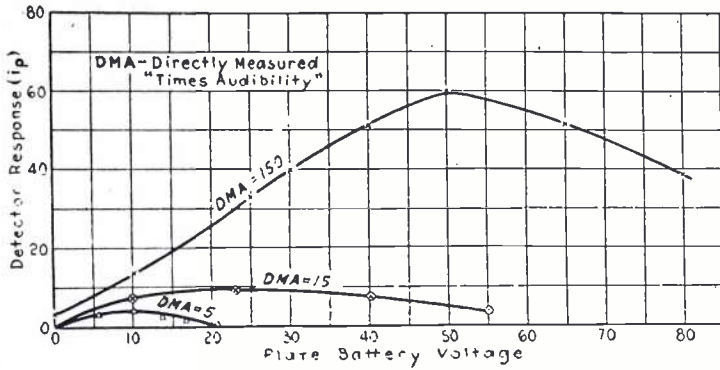

Figure 2

siderable "inert" gas, as a result of incomplete evacuation. Their response under such conditions is greater than for all other commercial tubes tested except for the UX-200-A. This will be discussed later.

The behavior of a potassium sodium alloy detector under conditions of strong and weak signal voltages is shown in Fig. 2. This property is also possessed by the conventional high vacuum detector-amplifier tube. The condition of low optimum plate voltage is obtained for a much weaker signal voltage in the case of a potassium sodium alloy tube than for the conventional high-vacuum type. This is illustrated in Fig. 3. Not only is the potassium sodium alloy tube a more efficient detector at low plate potentials and low signal voltages, but it is also a more efficient one at high plate potentials (0 to 50 volts) and strong signal voltages. The comparison is made using the optimum plate voltages for the conditions of a strong and weak signal voltage, according to the curves of Figs. 2 and 3.

2. Comparative Efficiencies. Fig. 4 shows the results of comparative tests on various typical tubes to illustrate the present comparative efficiency of the potassium sodium alloy detector. Since making this test the Radiotron

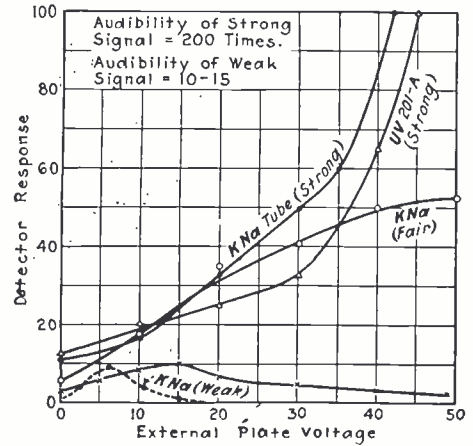

Fig. 3. Variation of response with plate voltage and input voltage

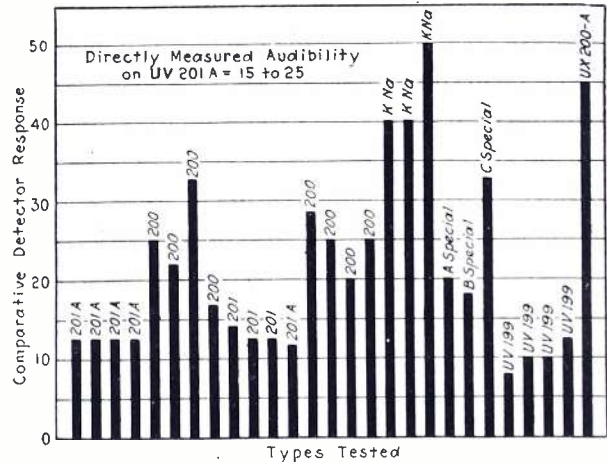

Fig. 4. Graphic results obtained from the various types of detector tubes tested

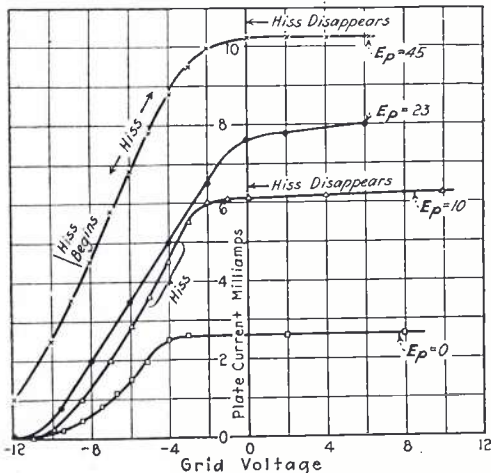

Fig. 5. K Na tube 1924—Showing peculiarities in characteristic curves for tube two years old

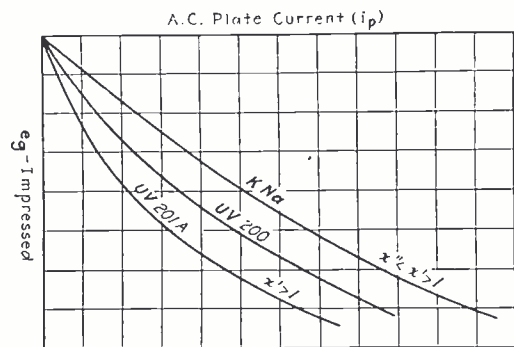

Fig. 6. The relationship of Impressed signal voltage on the A. C. plate current of three different types of detector tubes

UX-200-A has been put on the market and one typical comparison is added, showing it to be about as efficient as the potassium sodium type, but requiring optimum plate voltages of 40 to 50 as compared with 10 to 20 volts for the potassium sodium tubes on weak signal voltages.

3. "Hard" and "Soft" Tube Peculiarities. Attention is again called to the fact that increasing the filament temperature gives the "gassy" potassium sodium alloy tube characteristics of a high vacuum amplifier. This is especially true of the shape of the characteristic curves of such tubes also illustrated in the bulletin referred to. As a matter of interest Fig. 5 is given showing how a potassium sodium alloy tube behaves during the change in grid potential indicated by the abscissa of the curves. While the data taking operation is proceeding a hissing sound occurs in phones in the plate circuit, then the ranges of  $E_g$  indicated, as if ionization were setting in, but the curves are not "kinky" as those of gas content tubes, and for higher values toward  $(+E_g)$  the hissing ceases. This tube in use gives both the sensitive detector performance on weak and strong signal voltages, and the efficient amplification of strong amplifier input voltages. In either service it is a considerable improvement over the same tube not primed with the alloy. The degree of rise and fall of plate current during the warming up process and the attendant hissing noise were decreased by more thoroughly outgassing the electrodes with the aid of a high frequency induction furnace. However, such tubes were seemingly just as sensitive as those which were more "gassy." The transient plate current characteristic shown in Fig. 1 could not be eliminated by heat treatment and long continued evacuation, hence it seems that the transient "warming up" current and hissing is due to increasing activity of the alloy molecules as the alloy vapor pressure increases.

### "Square Law" Variation

It has been generally assumed that thermionic tube detectors obey a "square law" relation, that is, the a-c. component of plate current  $i_p$  is:  $i_p = K (e_g)^2$  where  $e_g$  is the impressed or signal voltage on the grid circuit. In general  $i_p = K (e_g)^x$  and for potassium sodium alloy tubes repeated variations showed that  $x$  is more nearly unity than for either "soft" or "hard" detectors. This is illustrated in Fig. 6. This should mean quite an improvement in reception of radiotelephone currents, as it would give more nearly the desired condition of the ideal linear rectifier.

Further work has shown that alkali vapor detector tubes, especially those containing the molecular alloy of potassium and sodium, are ideal tubes for durability, true tone reproduction and non-critical adjustment of plate and filament voltages.

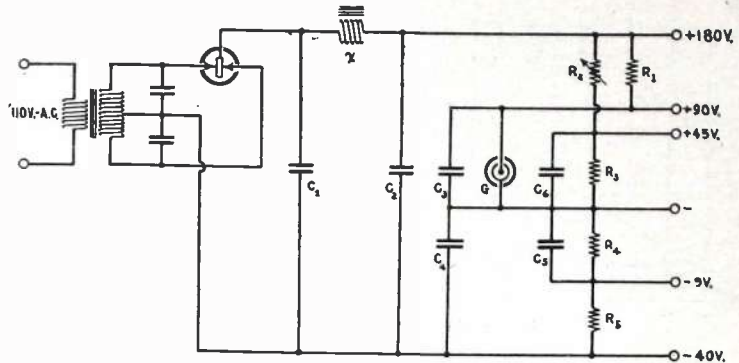

Schematic diagram of the eliminator discussed in the article below

## Motorboating Cured

Considering the effects and elimination of motorboating with B eliminators—By Zeh Bouck\*

A RATHER widespread interrogation has been aroused lately as to whether a "B" battery eliminator can be used with resistance coupled amplifiers. A negative answer to this question has been so generally forthcoming that there exists among the trade a general idea that it cannot be done. However, the writer has used various types of battery eliminators in conjunction with resistance coupled amplifiers for several years without experiencing the least trouble that could not be attributed to faults other than those inherent in a properly designed line power device.

The principal objection raised on the negative side of the argument is the tendency of the resistance coupled amplifier—eliminator combination to motorboat.

Motorboating is a low frequency oscillatory disturbance, with a period varying from two to three seconds to fifty oscillations per second. Above this frequency, its nomenclature changes, and it becomes a howl. Motorboating may be encountered under three illuminating conditions. A resistance coupled amplifier operated from a "B" battery will occasionally put-put-put in the approved nautical fashion. A transformer coupled set will, also, under propitious circumstances, motorboat when operated from a "B" battery eliminator. Thirdly, a more pronounced tendency is observed when a resistance coupled amplifier is operated from an eliminator. It is therefore a logical conclusion that resistance coupled amplifiers have an inherent propensity for motorboating, and that the use of a "B" battery eliminator contributes a similar propensity to all circuits on account of internal high impedance.

### Two Concomitant But Different Causes of Motorboating

Experiments tend to show that there exist two different effects which, necessarily appearing together, tend to set up motorboating in receivers operated from line power devices. These are the presence of a poor regulation curve and a comparatively high internal impedance of the eliminator. Quite naturally as the impedance rises the regulation curve becomes steeper and less desirable. While an interaction of these effects is doubtless present in all cases of motorboating, the predominance of one over the other is sufficient, in the majority of cases, to establish two categories of motorboating. Motorboating of the first order—due to the imperfection of the regulation curve—is generally noticed only during the reception of signals. It is particularly prevalent in multi-stage r.f. and regenerative circuits, the tendency increasing with the amount of energy fed to the detector tube, and may be sustained regardless of the audio amplifying system. The process is simple. Let us assume that a particularly high audio frequency peak causes a variation in average plate current to the receiver. Concomitant variation in the plate voltage applied to the r.f. tubes will be induced, due to the slope in the regulation curve on the eliminator. The amount of r.f. amplification and regeneration—the input to the amplifier—will vary with this change in potential, affecting the average plate current and repeating the process.

In the second effect, the high internal impedance of the eliminator acts as a coupling element between various circuits, giving rise to common circuit impulses. Motorboating from this cause is probably confined to resistance coupled amplifiers.

As has been observed, the use of re-

\* Engineer, Amsco Products, Inc.

sistance coupled amplifiers emphasizes the tendency to motorboat. This is due to the low "repeating period" of such systems, as determined by the RC constants of the coupling units.

### The Panacean Eliminator

Perfection in all lines would solve all of our problems outside of boredom. There would be no motorboating with an eliminator having a horizontal regulation "curve." As we approach this perfection we lessen the tendency to motorboat. The manner of approach is fairly obvious. It should be endeavored to keep the impedance of the filter system as low as possible, thru the use of comparatively low resistance choke coils, wound with large wire, large filter condensers and bypass condensers. Every voltage determining resistor should be bypassed to ground with at least one microfarad. A glow lamp should be shunted across the ninety volt terminals, limiting the potential variations applied to the radio frequency circuits.

### Importance of Obtaining C Bias from the Eliminator

It is highly desirable to provide for "C" battery elimination by an IR drop between the center tap of the transformer and the "B" minus terminal. Any changes in the average plate current will then immediately set up counteractive potentials in the grid circuits, thus still further tending to stabilize the entire system.

(The proper biasing of the entire receiver is, of course an important corrective measure against motorboating. Motorboating, as has been observed, is almost always accompanied by rectification—the change in the average plate current value—which can be eliminated throughout the receiver, with the exception of the detector circuit, by correct biasing.)

The accompanying diagram shows graphically the ideas outlined above. It will be rightfully remarked that the circuit varies only slightly from the conventional arrangements. However, such changes as have been made are sufficient to make all the difference between operation and motorboating with many receivers. Choke X has an inductance of about 20 henries. Condensers C1 and C2 are at least six microfarads each. The glow tube "G" is connected between the ninety volt tap and ground.

While trouble will seldom be experienced with an eliminator of this type, an obstinate resistance coupled combination may occasionally be found. Regardless of the excellence of the line power device, an interaction between audio and radio frequency circuits may maintain oscillations or motorboating. A radio frequency choke coil, connected between the first coupling resistor and the isolating condenser will often help matters, particularly in neutralized r.f. systems.

The refractory amplifier can also be stabilized by staggering the RC constants of the individual stages. This system is more than analogous to the

stabilization of a balky r.f. sequence by the detuning of an intermediate stage. The frequency at which two or more resistive coupled stages will motorboat is determined largely by the RC constants of the individual circuits. The oscillation is, of course, an "overall" disturbance, a prerequisite for which is a common repeated period (one might almost say resonance point) in the individual circuits.

The staggering process consists of employing different resistor and capacity values in the various stages. Coupling resistor values may vary between twenty-thousand ohms and three hundred thousand ohms, and the capacity variations between .006 mfd. and 1 mfd. The isolating capacity may be reduced to the lower value on one stage without appreciable loss in the lower frequencies.

## 11 Tubes for Power,—Plus

*Describing a super-heterodyne par excellence for distant reception through local interference—By Hollis De Neefe*

**P**RESENT day broadcast congestion makes imperative a high degree of selectivity in the receiver.

Further, those who live within the shadow of a number of powerful locals may also experience a blanketing effect from these stations. That is, their receivers may be sufficiently selective to tune out the offending broadcaster, but considerable dial space each side of the peak of the local wave seems to be "dead."

This condition is often encountered with a super-heterodyne, particularly with those which use but two intermediate stages or an inefficient, poorly designed intermediate amplifier. It is probably safe to say that the super-heterodyne is the only circuit sufficiently selective to cut through the locals and receive distant broadcasters with but a few K C separation, but it also stands to reason that the super must be sensitive enough to pick up the weak

degree of selectivity. Further, the high intermediate frequency employed (125 KC) minimizes the repeat point and harmonic annoyance so common to those supers using lower frequencies.

Reference to the schematic will disclose several interesting things in connection with the circuit. The pick-up coil is not in inductive relationship with the plate coil of the oscillator. As a result, a desirable wave form is produced by the system. Five intermediate stages, each of which acts as a filter as well as amplifier, are used.

The first detector uses the conventional grid leak and condenser combination for accomplishing rectification, since this arrangement is somewhat more sensitive to weak signals than a detector biased by a C battery. A three tap loop is used, and regeneration is afforded by a small feed-back condenser, using the familiar Rice split-loop method. Regeneration is not needed in

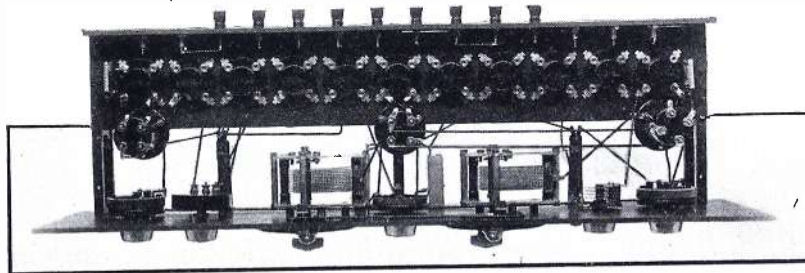

Airplane view of the 11 tube super. The entire assembly is on a 3/2 x 24 in. subpanel

distant signals struggling with the broad carrier of the powerful local.

The receiver\* described here incorporates both sensitivity and selectivity to a remarkable degree. 5 intermediate stages are used, and three stages of transformer coupled audio. It is a decided tribute to the careful matching of the transformers that there is no instability experienced with this arrangement. In actual tests, it was found possible to run the potentiometer three quarters negative before oscillation occurred in the intermediate amplifier. As said before, the careful matching of the intermediate transformers gives a high

this loop circuit for added sensitivity, at least under all ordinary conditions, but it serves another useful purpose here as in any other loop-operated receiver.

That is, a peculiar and annoying shielding effect is often encountered, when a loop set is operated in a steel building. Under these conditions, it is sometimes impossible to receive stations from even moderate distances. Regeneration in the first detector reduces the resistance of the loop circuit, lowers the threshold value of the tube and results in greatly increased sensitivity and selectivity of the receiver as a whole.

The oscillator coupler is of the tuned

\* Complete construction article in RADIO MECHANICS for April.



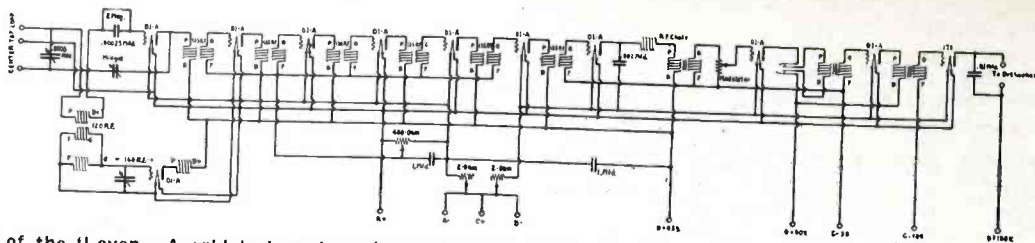

Schematic of the 'Leven. A grid leak and condenser is used on the first detector for maximum sensitivity while the second detector rectifies with a negative C bias. Observe the unusual method of oscillator coupling. The pickup coil is not in inductive relationship with the oscillator plate coil

grid type, and since one side of the oscillator condenser, is at ground potential, annoying hand capacity on this dial is completely obviated. Regeneration and consequent oscillation in the intermediate amplifier is controlled by means of a potentiometer. In actual practice this method has proved to be the most satisfactory for super-heterodyne intermediates.

The second detector accomplishes rectification by means of a negative bias furnished by a C battery, instead of the usual grid leak and condenser. The added sensitivity of the latter is of no value here, on account of the high R. F. amplification preceding the detector. On the other hand, and for this same reason, it is essential that the detector have ample handling capacity for the large amount of energy fed into it.

The volume control is a high resist-

Eight of the transformers are mounted under the sub panel, and in such a manner that connecting their grid and plate terminals to the grids and plates of the respective tubes resolves into merely soldering two lugs together. To these short leads we can give partial credit for the receiver's startling performance.

On a powerful receiver of this type, it is advisable to use a 171 tube in the audio output stage, for no other semi-power tube can be expected to handle the volume delivered by the set. For the best results, this tube should be operated with an applied plate voltage of 180. At this potential, however, the plate current of the 171 is heavy enough to cause damage to the speaker windings.

Since the space available is quite limited, and it was not desired to increase the size of the sub base, it was decided

venting distortion and instability in the audio amplifier.

The filament supply to the tubes is controlled by two 2-ohm rheostats. One of these regulates the current fed to the first six tubes, and the other controls the remaining five, including the half ampere power tube. Ballast resistances could be substituted for the rheostats if desired, but slightly greater efficiency can be gained by close regulation of the filament potentials, particularly in the case of the oscillator and the intermediate amplifiers.

The list of parts used in the original model built in Radio Engineering's Laboratory is as follows:

- 1 Melocoupler, type 160 R. F.
- 1 Melocoupler, type 120 R. F.
- 6 Melocouplers, type 135 R. F.
- 3 Meloformers
- 11 General Radio UX sockets
- 1 Tinytobe .01 mfd. fixed condenser
- 1 Tinytobe .00025 mfd. fixed condenser
- 1 Tinytobe .002 mfd. fixed condenser
- 2 Tobe 1. mfd. bypass condensers
- 1 2 megohm Tobe vacuum Tipon leak
- 5 Yaxley pup jacks
- 9 Eby binding posts, marked as follows:
  - A—, A+, B—, B+45, B+90,
  - B+180, C+, C—, C—40
- 2 Amsco .0005 mfd. S. F. L. Allocating condensers
- 1 Amsco Orthophone
- 1 Aalco loop
- 2 Yaxley 2 ohm rheostats
- 1 Yaxley 400 ohm potentiometer
- 1 Centralab 500,000 ohm modulator
- 1 Silver-Marshall type 276 long wave choke
- 1 Silver-Marshall type 340 midget condenser
- 1 Carter Hold-Tite jack switch, two springs
- 1 Carter Hold-Tite Jack, type 104, double circuit
- 3 Garfield Radfon brackets
- 2 National Velvet Vernier dials, type C
- 1 Bakelite or hard rubber front panel, 7 x 26 ins.
- 2 Bakelite or hard rubber sub panels, 3½ x 24 ins.
- 50 ft. Aeme Celatsite wire

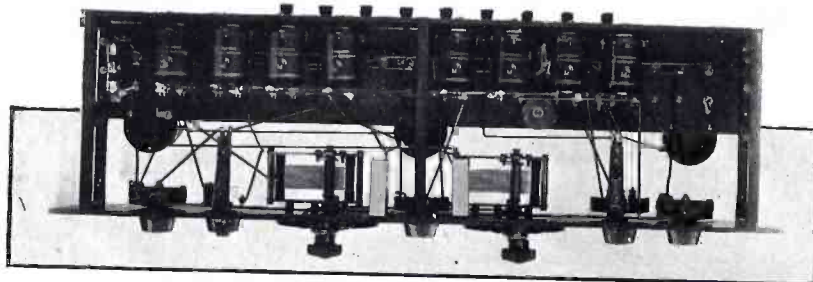

Underneath the sub-panel of the 11 tube super. The method of mounting the transformers makes extremely short grid and plate leads possible, and materially assists the unusual efficiency of the outfit

ance potentiometer shunted across the first audio transformer secondary, and with the center tap connected to the grid of the first audio tube. This method of volume control regulates the signal intensity from a whisper to full blast, but in no way changes any of the tone characteristics. Since this volume control is used on the first audio stage, it also provides regulation of the volume when a power amplifier is plugged into the first audio jack provided for that purpose.

The mechanical design of the outfit is quite novel, and is very efficient as well. It is no small feat to design an 11 tube receiver on a 7 x 26 ins. panel and 3½ x 24 ins. sub panel, and yet avoid crowding of parts. In order to accomplish this successfully, a special layout was employed.

to omit the loudspeaker coupling device on the receiver. Fortunately, the Amsco Orthophone has but recently appeared on the market and is especially designed for just such cases. This device consists of a pair of leads designed to plug into the output-jacks, and a pair of jacks into which the loudspeaker is plugged. So connected none of the plate current of the 171 can pass through the speaker, and only the A. C. component of the signal actuates the unit.

A long wave choke coil is used between the plate of the second detector and the input to the audio amplifier. This choke, in combination with the .002 mfd. condenser, bypasses the R.F. in the detector plate circuit directly back to filament, thereby pre-

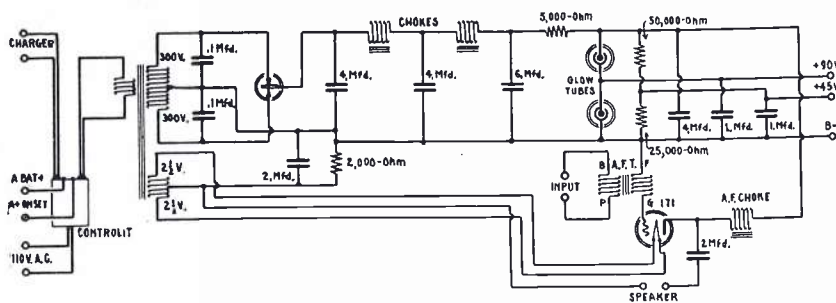

Circuit diagram of the Glo-limiter. The 90 volt tap and 180 volt taps are directly regulated by the two glow tubes. The 45 volt tap, stabilized by a shunt resistance, will not vary appreciably, for the glow tubes assist in maintaining its output constant

## The Glo-limiter

*The first circuit data for a power pack whose entire output is constant regardless of line or load—By H. F. Van Holm*

**R**ELIABILITY is the feature most desired today in B supply and power amplifier equipment. As is well known, the voltage of dry or storage batteries is a relatively constant and fixed quantity. Unfortunately, such is not the case with B eliminators, for the output of these devices may vary over wide limits, according to the line conditions encountered and the amount of plate current drawn.

Particularly in rural communities where the line voltage varies to a great extent, this characteristic of B eliminators is a decided disadvantage, and is apt to give rise to irregular and uncertain reception. Fortunately, there is standard equipment now on the market from which a constant voltage supply can be constructed easily. Up to the present time, however, no accurate data and circuit constants have been given for such an outfit, such as is here described.

For the first time, then, we present a combined B eliminator and power amplifier\* which combines all of the desirable features now known to the industry. This particular device has been so designed that it will deliver reliable service at all times. There is absolutely no guesswork connected with the unit. There are no variable controls to adjust, and hence nothing to get out of order.

This constant B supply and power amplifier can be used with any receiver and, after it has been attached, it requires no further care. An analysis of the various features will be of interest, and particular attention will be directed to the most outstanding ones. The design of each component part is amply oversized, and so we need not concern ourselves with a discussion of the physical characteristics of the individual units.

\* Complete construction article in RADIO MECHANICS for April.

The primary circuit of the power transformer is connected to an automatic relay, which is in turn wired in series with the positive lead of the A battery and the receiver with which the outfit is to be used. This relay is also provided with a receptacle for the trickle charger cord. With this arrangement, the filament switch on the receiver controls the operation of the power pack and of the trickle charger,

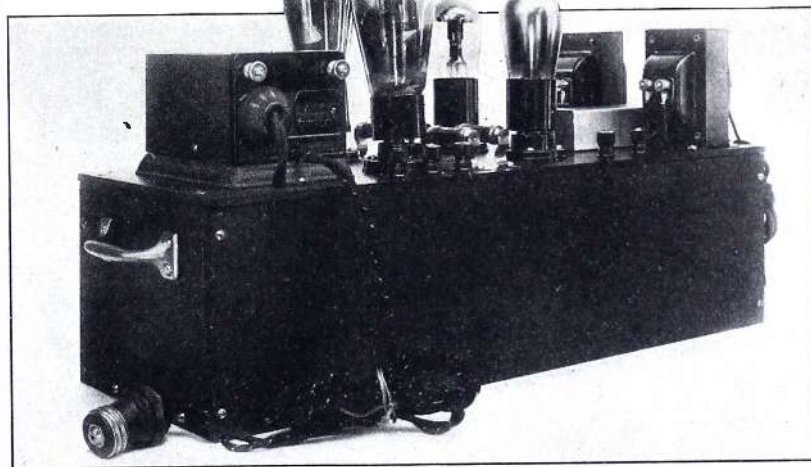

The Glow-limiter completely assembled and ready for operation. All high voltage leads are completely housed within the base

which is a decidedly convenient feature.

The power transformer is provided with two secondary windings, each of which is center tapped. The high voltage secondary delivers 300 volts each side of the center tap, and this value is applied to each anode of the Raytheon B. H. rectifier. This portion of the rectifier circuit and also the filter circuit are standard, except that the filter condenser capacities are somewhat higher

than customarily used, so that adequate filtration is provided.

Two CX 374 glow tubes are wired in series, and shunted across the output of the filter system. These tubes possess the unique property of absorbing or releasing current so as to hold the voltage developed across them constant at 90 volts, within very close limits. The common junction of the two tubes is therefore used as the 90 volt tap, and the high voltage end provides exactly 180 volts, which is the correct maximum plate potential for the CX 371 power amplifier.

The 180 volts thus obtained is applied to the plate of the CX 371 through a high inductance choke, and the output of the tube is fed to the loudspeaker through a 2. mfd. filter condenser. This arrangement prevents demagnetization of the speaker and possible burnout of its windings by the heavy plate current of the 371.

It should be noticed that the speaker return is connected to the center tap of the filament lighting secondary. This is the best possible arrangement, for the A C component of the signal thus encounters no resistance in its return to the point of lowest potential.

Grid bias for the power tube is provided by a 2,000 ohm fixed resistance, which is connected between the B minus lead and the center tap of the filament lighting secondary. Since the plate current of a tube must return to its own filament, the plate current of the 371 must flow through this resistor,

and the voltage developed across it can be used conveniently for biasing purposes. This resistor is bypassed with a 2 mfd. condenser. This condenser is very important, but the necessity for its use seems to have been overlooked by most engineers. A marked improvement in both quality and volume results when the grid biasing resistor is properly bypassed.

The mechanical design of the outfit merits more than passing mention. All

of the high voltage leads are completely housed, and no damage can occur to the wiring regardless of how the unit is mishandled. The various fixed resistors are mounted on the top, where they are readily accessible. It may be necessary to change the values of one or two of these when the unit is adapted to a particular receiver, and the position in which they are mounted greatly facilitates this change.

A 4. mfd. filter condenser is shunted across the 180 volt tap and B minus and, in combination with the glow tubes, it effectually stabilizes the entire output, removing any trace of A.C. hum. The 90 volt and 45 volt taps are separately bypassed with 1. mfd. condensers.

This generous apportionment of large capacities is reflected in the unusual performance of the outfit. The results from the unit are equal to those obtained from fresh dry batteries, with

able high resistance in the negative line, so that the entire output of the power unit must flow through it, and the potential difference thus obtained is available for C bias. Using this method, we are confronted with some undesirable conditions. First, the resistance used must be able to handle heavy currents without variation in value, for it may be called upon to carry 50 or 60 mils, possibly more, otherwise, reception will be uncertain and noisy, and poor tone quality results. Second, unless sizeable amounts of bypass capacities are used at the proper points, the receiver will howl due to the presence of resistance coupled audio feedback. Instability sometimes results, and A. C. hum is often introduced when this method is employed. Third, the variation of the resistance when the C bias is adjusted causes a variation in the output voltage on the plus B taps, according to the

desirable, for the current drawn by the potentiometer would exhaust the C battery in a short time.

In the eliminator described here, any one of the three methods could be used satisfactorily, because the output voltage is a definitely known quantity. However, the system employed was finally decided upon for it was found to be equal or better in performance than either of the others outlined. The biasing resistor is called upon to carry only the plate current of the power tube. Since the normal plate current of the 371, with 180 volts on the plate, is about 20 milliamperes, and the voltage developed across the resistor is but 40 volts, this resistor is dissipating only .8 watt, and will remain accurate and noiseless under these conditions.

The indicated values of the various resistances will be found to be correct for an average receiver. Some multi-tube receivers, however, and particularly super-heterodynes, draw plate current for a number of tubes from the 45 volt tap. If it is desired to use the eliminator with such a receiver, it is advisable to decrease the value of the 50,000 ohm resistance or to use a Clarostat in its place. This value is best determined by trial and, once found, it need not be changed again.

The resistance in series with the high voltage output and the glow tubes is not absolutely necessary, for the glow tubes provide adequate handling capacity for regulation without it. It is included here as a measure of precaution, in case the supply set should be turned on when the filaments of the receiver tubes are not on. In such a case, practically the entire output of the eliminator would be shorted through the glow tubes, and they are not rated to withstand a current in excess of 50 milliamperes.

The automatic switch assures that the tube filaments will be lit when the power supply is on, and this resistor can be omitted if desired. In some cases, when the power pack is used on a large receiver, irregular behavior of the glow tubes may be noticed and, possibly, they may fail to function. This indicates that insufficient current is allowed to flow from the filter output, and the series resistance should be shorted out of the circuit.

If it is desired to further safeguard the system, it is suggested that a 4 volt-199 Amperite be inserted in place of the 1,000 to 5,000 ohm resistance. The Amperite does not possess sufficient resistance to alter the characteristics of the circuit, nor will it decrease the voltage output. In case of a short circuit, however, or power applied to the eliminator when no current is drawn from it, sufficient current to blow the Amperite will flow through it. This little kink is worth using, for a standard fuse is thus available to the constructor, and it can be inserted without circuit changes or mechanical alterations.

A decided convenience in the assem-

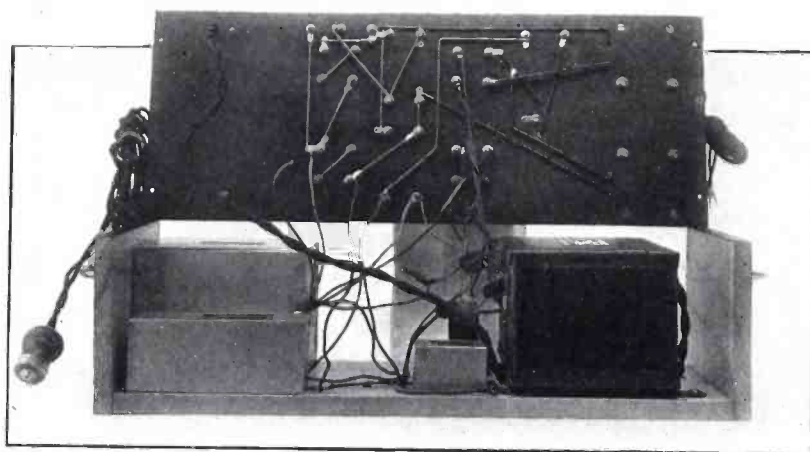

The component parts of the Glo-eliminator, before final assembly. Despite the unusual design and efficiency of the unit, the construction and wiring are very simple

the added advantage that there is no gradual drop in voltage and subsequent loss of volume and quality. Eliminators of mediocre design and under-proportioned units have been a source of trouble on many sets. However, the design presented here will perform satisfactorily on any receiver.

It is well to say a word at this point about the advantages of lighting the power tube from raw A. C. We have conducted extensive laboratory tests on power amplifying stages, using raw and rectified A. C. for the A, B and C potentials and have compared the results from this method with those obtained from batteries as a source of power.

Since the 371 type of power tube draws but .5 ampere of filament current at 5 volts, it is an easy matter to furnish this amount from the 6 volt storage battery. But let us consider the reason why it is better to light it from A. C. We will assume that the B eliminator used possesses ample power for plate supply, and that there is a surplus available for C potential.

Now, if we desire to furnish grid bias to the power tube through the B eliminator it is necessary to insert a suit-

amount of resistance used and the corresponding voltage drop across it. It is very evident that this system possesses many drawbacks, and we can therefore consider it as unsuitable for our purpose.

Another arrangement is to furnish the C bias for the power stage by means of a dry battery, when the filament is energized from a storage battery and the plate potential supplied from a B eliminator. Strange though it may seem, this arrangement is poorer than the first one outlined. The voltage supplied by the C battery is relatively constant, whereas the voltage applied to the power tube may vary according to line conditions. Here, then, we have a case of too much bias one minute and too little the next.

A series of tests was run on a receiver supplied in this manner, and it was found that the exact value of the C battery was a very critical quantity, in order to secure the best results. To realize the utmost gain from this system, it would be advisable to shunt a potentiometer across the C battery so that this potential could be adjusted accurately to the correct value. Obviously, this would be un-

bly of the outfit is afforded by the Dongan power unit used. This unit contains, in one compact case the power transformer and two filter chokes. The necessary terminals are all provided in the form of flexible leads, which extend through suitably insulated holes in the case. Mounting and wiring are greatly simplified through the use of this unit and there is less danger of short circuits or incorrect connections.

The list of parts, as used in the original laboratory model of the Glomimator, is as follows:

- 1—Dongan Power Unit, type No. 3516.
- 1—Dongan Diatonik or type H audio transformer.
- 1—Dongan Diatonik or type H audio impedance.
- 1—Aerovox type B H Raytheon condenser block.
- 1—Aerovox 4. mfd. filter condenser, 300 D. C. working voltage.

- 1—Aerovox 2. mfd. filter condenser, 300 D. C. working voltage.
- 1—Aerovox 2. mfd. bypass condenser.
- 2—Aerovox 1. mfd. bypass condenser.
- 1—Aerovox buffer block, two .1 mfd. capacities.
- 1—Brach Controlit.
- 4—Na-ald UX Sockets.
- 1—Aerovox Lavite resistance, 50,000 ohms, or 1 Clarostat.
- 1—Aerovox Lavite resistance, 25,000 ohms.
- 1—Aerovox Lavite resistance, 2,000 ohms.
- 1—Aerovox Lavite resistance, 1,000-5,000 ohms (optional).
- 5—Eby binding posts.
- 4—Pair Daven grid leak mounting clips.
- 1—7 x 18 Bakelite or hard rubber panel.
- 1—Raytheon B H rectifier.
- 1—CX-371 power tube.
- 2—CX-374 Glow tubes.

The packing of these large sets is generally through "floating" the load on a simple cradle, which cradle ordinarily slips into tracks attached to the sides of the case. This means that the cradle can be attached to the bottom of the set while it still stands on the workroom floor, so that the mere slipping into the tracks of the case completes the packing operation, except in such instances as high cabinets, when it is usually blocked at a point somewhere near the top. The blocking is generally done with small pieces of balsa, a wood almost as soft as pith, though some shippers use cork to some degree. Others use some of the soft sheet material like cellupacking. More often than not, such cases are used by the cabinet manufacturer in shipping the cabinet to the radio manufacturer, the latter installing his set, and then shipping the finished product to the market.

Medium size sets find an equally ideal package in the plywood. The cabinets can be mounted on the board which forms the "cradle," and this cradle proves of great convenience in handling in the radio plant, as the hands need not then at any time touch the finished cabinet. Upon the completion of the installation of the chassis, the whole is then ready to be slipped into the tracks of the case, and the attaching of the cover completes the package.

You will note that in each instance we suggest the desirability of floating the load. This obviously protects the

## Packing Radio Parts

*Recommendations for the use of proper materials in packing cases according to the nature of the shipment—By Tift\**

IT is perfectly evident that there are few lines in which the proper packing of goods is more important than in Radio. Yet it seems as though all the articles written are based upon the writer's desire to emphasize the advantages of his own particular kind of package, with a complete ignoring of the merits of other types of package. Let us, therefore, be fair in our consideration of different kinds, and frankly admit that each has advantages in its own field. The writer's personal interest lies in a wooden package, so in this spirit of fairness, let us consider first, the items in which his interest does not lie.

For anyone to condemn the paper box off-hand, is so unreasonable that it indicates a narrowness of vision that should not exist. The packing of radio parts is not unique, but the packing of sets is, and so we shall confine our discussion to those. For small sets, therefore, viz., those of small dimensions and small weights, the corrugated box, with its so-called "air-cushions," is an excellent package, combining convenience, cheapness and lightness. That is a field, therefore, in which it is logical that such a box should dominate, and where such a package is giving satisfactory service, it is folly to advocate a wooden box.

I think that everyone familiar with packing, will admit that many sets have been packed in boxes of insufficient strength to carry the weight and size, when the perfectly logical box for such sets is a wooden one. Of the latter type of case, there are many

varieties and specifications, but the plywood case, viz: one made of three plys of wood, glued together, is pre-eminently adapted to goods of this character, where extreme strength,

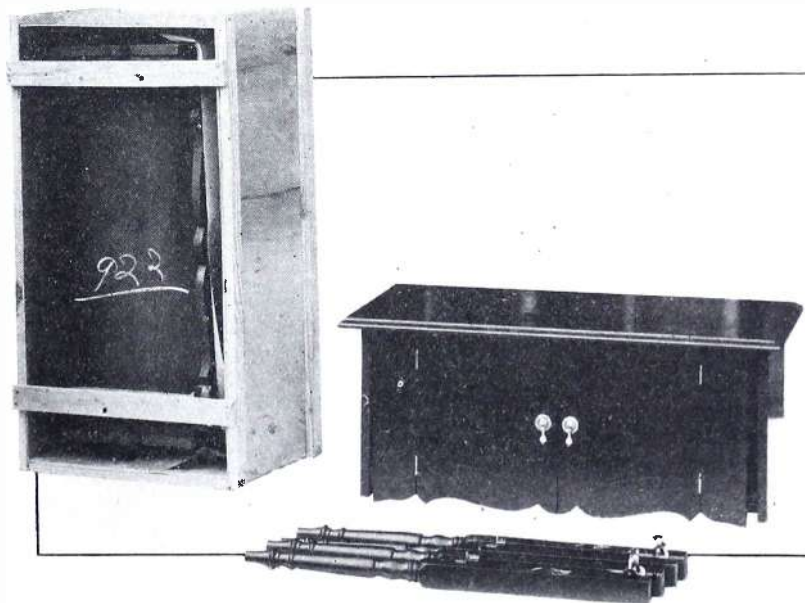

A step in the proper crating of a radio table to insure safe shipping

rigidity, lightness and protection against dust and moisture are of paramount importance. As a result of these advantages, plywood has become "standard" with the large set line, hardly any consoles or similar sets ever being shipped in any other type of case.

set from many jars so that very delicate apparatus can be safely transported. Yet it is only fair to say that some manufacturers of large cabinets think us too conservative when the legs of the cabinets are very substantial, and mount their furniture directly onto the bottom of the box.

\* Tift Bros.

# Tuned R. F. Coil Design

An Analysis of Plate Resistance Stabilized Radio Frequency Amplifier Systems\*

MULTI-STAGE tuned radio frequency amplifier systems known to the present art may be divided sharply into three distinct types. There are the various forms of bridge circuits, the so-called "loss-stabilized" circuits and more recently, the zero-reactance plate-load circuits. These three types are identical in their purpose, that of partially suppressing, or totally nullifying, self-oscillation or regeneration tendencies in a cascaded amplifier. They differ only in their method of attack; their aim is at a common object.

It is well known that when a reactive load is placed in the plate circuit of a high-frequency amplifier having a tuned input circuit a voltage is built up across this reactance which will tend to feed back through the tube grid-plate capacity and cause regeneration. Unfortunately this reactive load is nearly always necessary in order to effectively transfer energy to the next stage, since pure resistance coupled systems are very inefficient at high frequencies. When this reactance is positive, that is, predominantly inductive, the feed-back re-inforces the grid input and causes what we have come to call "positive regeneration" or when the degree is aggravated, self-oscillation, that is, steady generation. When the load is a negative reactance, that is, a capacity, the regeneration is negative and the tendency is toward suppression of the grid input voltage, resulting in less amplification and, of course, no self generation. This condition is rare in practise, altho the writer has seen several manufactured receivers which unwittingly used negative regeneration to obtain a flat gain-frequency curve, (in untuned systems). Since positive regeneration is far more important in this discussion it is pertinent that we consider its control, by the three methods, a bit further before passing on to our analysis of one particular system.

A limited degree of positive regeneration is usually desirable in receivers employing only two or three tuned stages in order to reinforce the amplification and gain selectivity. However, if this regeneration is not controlled or limited, it may build up to a sufficient value, depending upon the tube characteristics, circuit resistance, inductance, etc., to cause the receiver to oscillate and naturally destroy its utility.

In suppressing oscillation we may have three plans of attack. Since the regeneration is caused by a voltage of

a definite phase feeding thru a capacity we may either *limit or nullify the effect* of the capacity, *limit the voltage or change its phase* to one which will neither reinforce nor suppress the grid input voltage.

The bridge circuits all use the first plan of attack. They feed back, from the plate to grid circuits, a reversed phase voltage thru an auxiliary capacity or inductance which nullifies the feed thru the tube capacity. When these two voltages are exactly equal and opposite no regeneration can take place and the bridge is said to be perfectly balanced, and functions as an amplifier solely by virtue of the usual forward feed thru the tube. When slightly off balance some regeneration takes place which increases the amplification of the stage but also sharpens the circuits and may cause distortion by side band elimination. Thus this regeneration may or may not be desirable up to certain limits, and is often used to bolster up a receiver which would otherwise be ineffective. Some examples of bridge circuits are shown in Figure A, together with illustrations of the other two types.

The receivers using the second method of stabilization have, a bit unfairly perhaps, come to be called "loss-stabilized." The term is at the same time correct and erroneous, for altho they do throw something away to gain stability, by careful design and a judicious use of regeneration, they may gain back much more than they lost and thus become better receivers. These circuits prevent steady oscillation by either raising the limit of allowable feedback or limiting this feedback to a point below the existing allowable level. This involves some loss of stage gain which may or may not be regained, (and more), by the regenerative amplification which is always present. All of this class of receiver depend for their effectiveness on some degree of controllable regeneration, usually critical, or nearly so.

The third method of oscillation suppression, the zero-reactance plate load, is like the bridge circuits in that it may completely nullify positive regeneration or allow a limited quantity to take place. It does not, however, depend for its action upon a negative sense of fed-back voltage, but rather changes the power-factor of the load between plate and filament of the tube, (its output circuit), to unity, making a pure resistance load, with the voltage in phase with the A. C. plate current. Therefore no reactive voltage can exist and no effect is shown on the input grid voltage. This is accomplished by

balancing a positive and negative reactance, an inductance and a capacity, in the plate circuit, so that their sum is always equal to zero at the operating frequency. The output may then be taken off either branch of the balanced load. The circuit has recently been independently developed by several engineers and, so far as the writer is aware at this writing, no commercial example exists on the market.

A comparison of these three methods of oscillation suppression is extremely involved and as such is entirely out of the scope of this paper. We shall concern ourselves particularly with one type of the second method, loss-stabilization, by tube characteristic control, since it is popular among manufacturers of the usual five or six tube receiver and since an effective and satisfactory instrument may be designed thru its careful application.

Regeneration or oscillation in receivers of this type is due to seven main factors, a variation in any one of which either aggravates or nullifies the tendency. These are; the tube characteristics; its voltage factor, ( $\mu$ ), plate resistance, ( $R_p$ ) and its internal grid-plate capacity, ( $C_m$ ); the inductance and resistance of the tuned input circuit; the resonant frequency of operation and the positive reactance, ( $X_{a-b}$ ), in the plate circuit. That is, in the tube a high  $\mu$ , a low plate resistance and a high grid-plate capacity; in the tuned circuit a high inductance with a low resistance, (low-loss coil); and in the plate circuit a high positive reactance, (tight transformer coupling, high M) all make for positive regeneration or steady oscillation. Naturally, the higher frequencies also cause easier oscillation, since the reactance of the interelectrode capacity is less and all other things being equal, allows greater feedback. These statements, of course, neglect any stray electric or magnetic coupling which can always be reduced to practically zero by proper shielding, by-passing, etc., or nullified by spacing of units, etc.

With this information at hand we may now attack either the tube characteristics, the losses in the tuned circuit or the coupling link, (transformer). The tube  $\mu$  and grid-plate capacity are practically structural constants and cannot easily be modified. The plate resistance may be altered by a regulation of either the plate voltage or the filament emission, that is, either by a variable high resistance in series with the B battery or a variable filament rheostat. The tuned circuit can be made of high resistance in relation to its inductance either by actually designing it as such or purposefully inserting resistances in series or parallel with the completed circuit, metallic absorption, etc. A "differential" effect may sometimes be obtained by placing a metallic sheet as a condenser end plate or frame or a shield very near to the coil, or by a coupled tuned tertiary circuit whose absorption automatically varies with frequency, and is always of such mag-

\* From a paper presented before the Radio Engineers Club of Chicago.

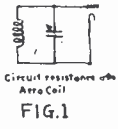
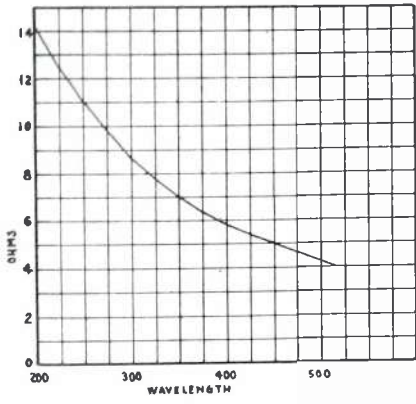

$R_1, E_p$  Curve  
201-A  
 $E_g = 0, E_c = 15$   
 $\lambda = 0$   
FIG.2

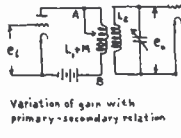
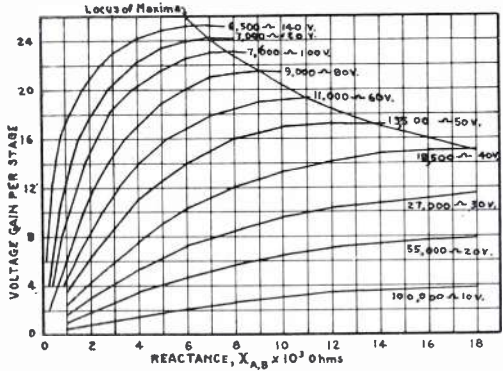
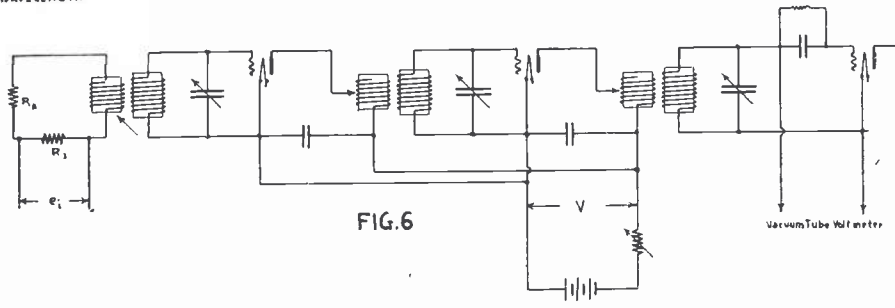
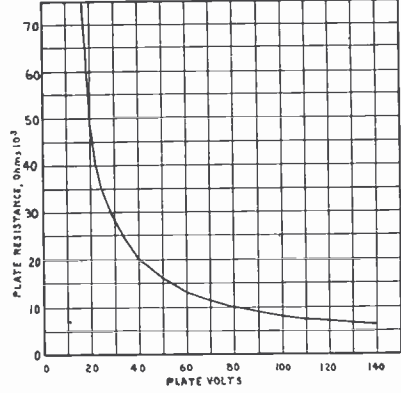

Locus of intersections showing optimum gain 201-A,  $\mu = B, 300 \lambda$

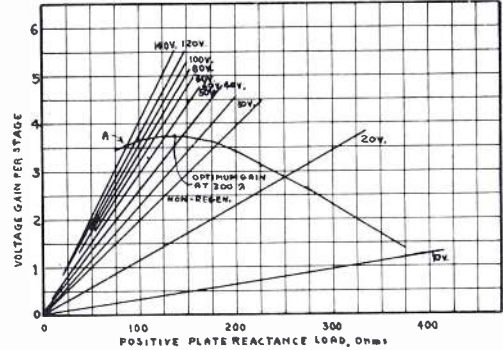
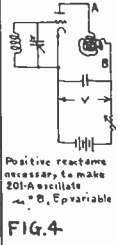
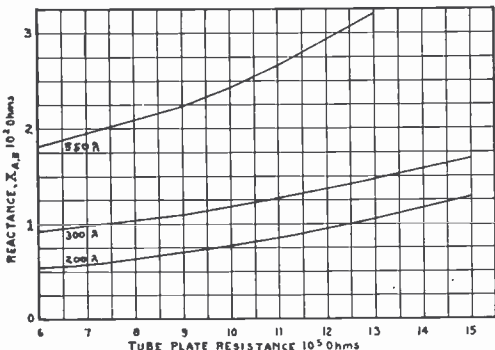
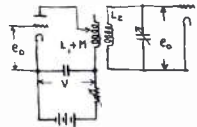

Figure 1. The resistance-frequency curve of the tuning coil used.  
 Figure 2. Plate resistance-plate potential curve of the average UX201A, used as the radio-frequency amplifier tube.  
 Figure 3. A family of curves showing non-regenerative voltage gain per stage with varying primary-secondary coil coupling, using the Aero Coil and the tube shown in Figs. 1 and 2.  
 Figure 4. The amount of inductive reactance necessary to make a UX201A tube oscillate.  
 Figure 5. The locus of intersections, determined from curves 3 and 4, which gives the optimum relation for the maximum energy transfer under the authors outlined conditions.  
 Figure 6. The experimental setup for verification of the theory and design of the completed system.

itude to make the receiver stable without at the same time being too far below critical regeneration.

In lowering the positive reactance of the plate circuit to such a value that steady oscillation cannot be maintained, the primary coil is either made so small, or so loosely coupled to its secondary, that the total of its self and mutual inductance never rises to a limiting value at the resonant frequency. This total may either be fixed or variable over the broadcast spectrum, the latter being preferable because of the poor frequency-energy characteristic of the usual fixed transformer. It is possible to so vary the coupling with tuning that the receiver is automatically maintained in a condition of critical regeneration over the band, altho this adjustment is usually so critical as to make its use impractical except in laboratory-model or carefully balanced factory-built receivers. Certainly it is not sufficiently fool-proof to allow its satisfactory assembly from a "kit" by the inexperienced builder.

In making a choice of the type of stabilization to use we may at once eliminate any attack upon the resistance or inductance of the tuned circuit. It is obvious that changing the inductance-resistance ratio of this circuit to a value sufficient to stop oscillation will seriously affect the selectivity of the receiver and thus destroy a part of its utility in gaining stability. This leaves the tube plate resistance and the plate load as the only allowable variables. The remainder of this paper shall deal with the optimum proportioning of their ratios to obtain maximum effectiveness.

Almost by inspection it can be seen that an extreme in either direction is undesirable. Low tube amplification combined with high transformer amplification, or vice versa, will not be as effective as a compromise between the two. A large plate load, which means an efficient transformer, will necessitate an extremely high tube plate resistance to suppress oscillation, while a low plate resistance, as represented by a good tube with a high plate voltage will allow only a very small primary plus mutual inductance which means poor stage transfer of energy. In either case the stage amplification will be low and it is reasonable to suppose that an optimum relation exists, which, when determined, will give maximum gain under the prevailing conditions. Although this optimum condition is usually reached by a cut-and-try method in the design of such systems, its theoretical analysis is interesting and valuable in the determination of the proper constants. It is unfortunate that receiving systems employing regenerative amplification, (as this does), are much more difficult in their mathematical calculation than those employing perfectly balanced bridge circuits or zero-reactance plate loads which need not consider the magnifying effect of regenerative amplification.

In proceeding with the analysis, it is necessary to know the constants of the apparatus with which we must deal and their function of variation with other variables. The tuned circuit as has already been decided, should have a very low power-factor, that is, a proportionately high L/R ratio, (really the inductance divided by the square root of the resistance), over the useful spectrum. This means an extremely efficient coil of "low-loss" construction. The resistance-frequency curve of such a coil is illustrated in Figure 1 and the coil itself in appended photographs. The inductance of its secondary is 234 microhenries, to tune the spectrum with the usual 350 picofarad condenser.

Figure 2 shows the characteristics of the average UX201A tube, which is used as the amplifier. Since oscillation is to be controlled by a variation in tube plate resistance, obtained by a variation in plate voltage, the curve of this variation is necessary to our calculations.

Figure 3 is a curve showing the non-regenerative voltage gain per stage at 300 meters, of a tube and transformer combination having the characteristics as in Figs. 1 and 2, when the plate reactive load (the size of the primary), is varied. These are a family of curves, made at different plate resistances, (plate voltages), to show the effect of primary variation and tube characteristic variation. For example, take the first and highest curve, that of the tube operating at 6500 ohms plate resistance, corresponding to 140 volts on the plate. As we increase the transformer coupling, (L' plus M), the gain per stage rapidly rises until it reaches a maximum of about 25 per stage at 6500 ohms load reactance, after which it slowly falls as the optimum is passed. All the other curves are similarly taken at different values of plate resistance and all rise to a maximum at the value of load reactance corresponding to the tube resistance. (This is an axiom of such circuits). A line drawn through these points of maximum gain is a smooth curve and is the locus of maxima.

From an inspection of Fig. 3 it would seem that the most desirable point of operation would be at the highest gain, which would be at optimum primary for the lowest plate resistance. This would be true in the bridge or zero-reactance plate-load circuits, but is not true in the present case. Unfortunately, it is found that the stage will go into violent oscillation long before this optimum load is reached. It is next necessary to determine the amount of positive reactance necessary to make the circuit oscillate.

Figure 4 shows curves taken at three frequencies, (corresponding to 200,300 and 550 meters respectively), between the values of plate reactance necessary to produce critical regeneration and tube plate resistance. The curves could be obtained mathematically with a knowledge of the tube and circuit characteristics, but they are modified greatly by practice conditions and therefore are much more easily and

accurately determined experimentally, by the method outlined in Fig. 4. Taking the 300 meter curve, it is seen that the tube will oscillate, with the given circuit characteristics, with a positive plate reactance of less than 100 ohms! Note the great discrepancy between this value and the 6500 ohms necessary for the optimum primary. As the plate resistance is increased the amount of reactance to produce oscillation is also increased.

Figure 5 is an amplified section of the lower portion of Figure 3, drawn more accurately and to a much larger scale. The locus of intersections curve which determines the maximum gain, is arrived at in the following manner. For each plate resistance, (plate voltage), in Figure 3 a value of critical reactance is determined from the curve of Figure 4 and then set upon the corresponding curve in Figure 5. That is, for 6500 ohms plate resistance, (14A v.), we have at 300 meters, an allowable plate reactance of 95 ohms for critical regeneration. This is then stepped off as an abscissa on curve 5, projected upward to the 6500 ohm curve and a point thereby determined. This is point A, for illustration, in Fig. 5. For each particular plate resistance a point is thus determined and the locus of intersections drawn in. The curve reaches a maximum which then gives the optimum plate resistance and primary reactance at critical regeneration for 300 meters, with the other conditions as outlined.

Similar curves are drawn for other frequencies corresponding to the upper and lower limits of the broadcast spectrum. These optimum values, thus determined, are naturally not the same as those for 300 meters, but it has been found that, since the peaks of these curves are so flat around their maximum points, little is lost by designing the system for best conditions at some point near the middle of the spectrum and merely readjusting the plate resistor at other frequencies.

At first glance, (Fig. 5), it would seem that the stage gain of these systems, even at their optimum point, is extremely low when compared with that for other means of oscillation suppression. (3.75 as against 25.0) When this is compared with the 10, 15 and even 20 per stage gains shown in some commercial forms of bridge balanced receivers it would indicate great superiority of the bridge circuits. However, it should be remembered that these are non-regenerative figures, which are necessarily multiplied by a large factor representing the regenerative amplification, when the receiver is carefully adjusted. Near critical regeneration the regenerative contribution alone may be as high as 15 times, (Landon and Jarvis). Now 15 times 3.75 gives over 56 voltage gain, a very good figure for a single stage, which may be even greatly increased by careful adjustment around the critical value. At the same time the relative selectivity is greatly increased as frequencies slightly off resonance are not

amplified nearly as much as are the true resonant frequencies. These factors indicate reasonable grounds for the statement that in a one or two stage system, for the same degree of relative selectivity, a correctly designed loss-stabilized receiver employing critical regeneration may be far superior in sensitivity to a perfectly balanced bridge circuit of one or two stages which does not employ regeneration. This statement must be modified when the number of stages increases, or when the bridge is not completely balanced, thus taking an advantage from the regenerative effect.

The reason for limiting the number of stages to two in the foregoing statement is because of the cascading properties of balanced bridge circuits as contrasted with loss-stabilized circuits. Non-regenerative perfectly balanced bridge stages, giving as high as 20 gain per stage may be cascaded to almost any practical number of units, each of which will give 20 gain, output-input ratio. This is not true of regenerated loss-stabilized receivers, as the tendency towards oscillation increases much faster, (as the number of stages increases), than the overall amplification. That is, while the first stage may give fifty or 100 per stage, the second will give a great deal less, and the third much less than that, and so on. Thus two stages will not give the square of a single stage gain, or three stages give the cube, as do the bridges, but a great deal less. Increasing to four or five stages may even result in a decrease in over all gain, although the selectivity is much better. This condition is sometimes met in as low as three stages.

This fact was recently proved to the manufacturer of a high grade loss stabilized receiver using variable plate reactance stabilization, who found that his five stage receiver, using the same method of control as the two stage, showed very little gain in sensitivity over the two stage set, although the selectivity was so much better that it was necessary to insert fixed resistances in each tuned stage in order to retain the fidelity of high-note reproduction. If the five stage receiver had employed a bridge circuit with perhaps a small amount of controllable regeneration it would, of course, have been greatly superior to the two stage affair.

Thus far our data have been derived for a single stage with no input losses, (antenna or previous stage), and in the practical receiver design it is necessary to consider both the effect of regeneration and of these losses. Such an analysis, entirely mathematical, would be much more complicated than that of a single stage. Therefore the method shown in Figure 6, an experimental method, was evolved, which easily and quickly gives the proper solution. A two stage amplifier is shown, with variable interstage primaries and a variable antenna input coil, (which is also incorporated in the commercial model). The input to the antenna coil is measured in the usual manner with

the antenna and ground resistances, thought to be average, *in effect*. The output of the system is measured across the input to the detector tube by the aid of the usual vacuum-tube voltmeter. It is necessary to have the detector connected and lighted with its usual plate load because of the damping effect of this tube upon its transformer secondary circuit, thereby modifying the transformer characteristics.

A series of measurements of input-output ratios is then made, under the conditions of critical regeneration, (or just below), by varying both interstage primaries at the same time and varying the two RF plate resistances by means of the variable resistor. The curves taken at different frequencies in the

broadcast spectrum have the same general form as that of the locus of intersections in Figure 5, and are of the same general order, thus bearing out the previous work. Of course, the complete two stage setup shows much greater gain than the single stage used in Figure 5 but the order of optimum circuit constants is within reasonable limits.

The writer has used this method of designing receivers of the plate-resistance stabilized variety in a number of cases recently, and the optimum relations brought about by its use have, in every instance, resulted in a far smoother and more satisfactory device than those resulting from the usual cut-and-try methods.

---

## A Socket-Power Super

*Additional data on the design of an A. C. operated 01-A tube super-heterodyne*

---

SINCE the first presentation last month of the completely A.C. operated Victoreen super-heterodyne,<sup>1</sup> using 7 201-A tubes and a 171 power tube, additional laboratory experiments on the receiver have disclosed some more interesting facts relating to its operation. It is obvious that different conditions are encountered, when series wiring of the filaments is employed, than those met with when the usual parallel wiring is used.

In the first model, the grid return of each intermediate tube was made to its own negative filament, for one potentiometer could not be used to control all three tubes, since the filament of each was at a different potential. Then, in order to control volume and also possible oscillation, a variable high resistance was inserted in the common B plus lead feeding the plates of these tubes. This arrangement provided a satisfactory control for the purpose, for adequate regulation of the oscillatory tendencies of the intermediate amplifier was available even though 60 to 90 volts was used at the potential source.

However, it is generally acknowledged that a potentiometer is the best method of controlling the intermediate amplifier of a super-heterodyne. Therefore, as indicated in the schematic, it is recommended that the following changes be made:

First, the high resistance is removed from the plate circuit of the intermediate amplifiers. A high resistance potentiometer, such as the Carter, with a maximum value of about 1,000 ohms is then connected across each intermediate amplifier filament. It is advisable to use a high resistance potentiometer here, for those of lower values will bypass con-

siderable current around the filaments. The grid return is then connected to the center arm of the potentiometer and bypassed to ground with a 1. mfd. bypass condenser.

Two of these potentiometers are mounted on the sub panel, and need be adjusted only once. The one which controls the first I. F. tube can then be mounted on the panel, and will control the whole train. As a matter of fact, the potentiometers on the second and third tubes can be omitted, if desired, and the grid returns of these tubes made to their respective negative filaments. The potentiometer on the first tube will provide adequate regulation for the entire system, in this case.

Due to the fact that the maximum output of the 01-ABC Eliminator,<sup>2</sup> when built from the parts or originally listed, is only about 135 volts under full load, the speaker output coupling device has been omitted, for the plate current of a 171 tube, at this voltage, will do no damage. However, it may be desired to increase the handling capacity of the output voltages by using a B battery in series with the B plus Max. lead by substituting power transformers which have secondaries of higher voltage rating. In this case, the speaker must be protected by an output transformer or by a choke coil and condenser.

A volume control in the audio amplifier has been provided by a Clarostat shunted across the secondary of the first audio transformer. Such a device is an absolute necessity on a receiver of this type, for the R. F. amplification is so high that the volume on many nearby stations cannot be reduced sufficiently by the potentiometer.

As in the original model, regenera-

<sup>1</sup> Complete construction article in March Radio Mechanics.

<sup>2</sup> Complete constructional details in Radio Mechanics for January.



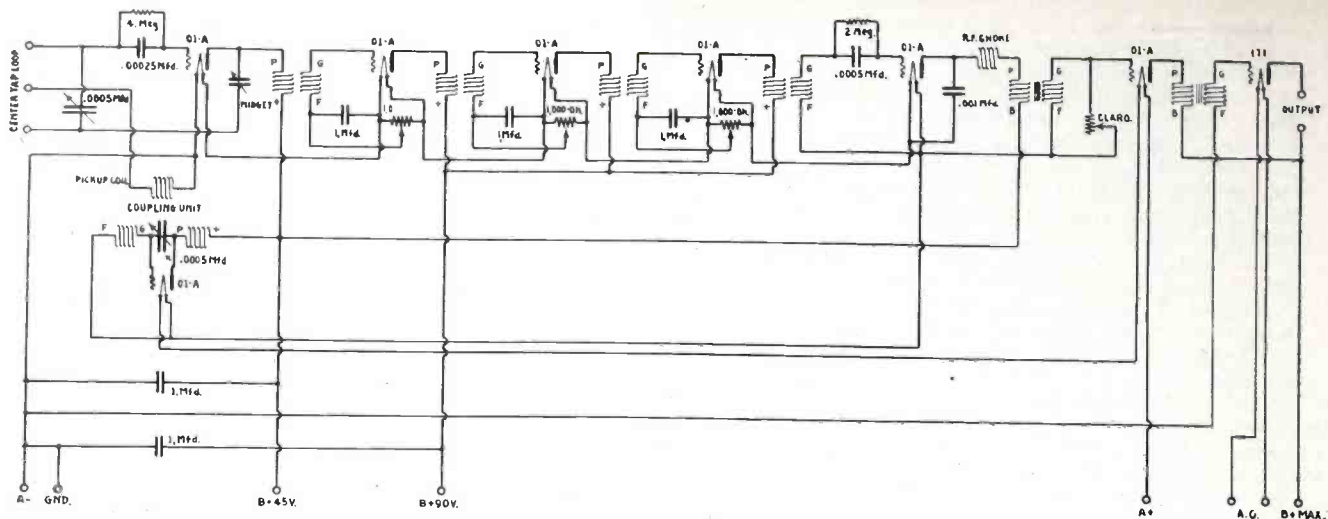

Schematic of the revised Victoreen Socket-Power Super-Heterodyne. The main changes consist of the use of potentiometers for the control of I. F. oscillation, a volume control on the first audio tube, and a slightly different sequence of series filaments

tion is used in the loop circuit. Aside from the greatly increased sensitivity afforded by this principle, the input circuit is so sharpened that the overall selectivity is considerably improved and cross talk is minimized. With regeneration in the loop circuit it is never necessary to use an outside antenna, even for long distance reception.

For all normal receiving conditions, single control is very satisfactory. However, under conditions of bad interference, it is better to use two separate tuning condensers, instead of the one control unit specified for the original model. The main reason for this is found in the characteristics of the superheterodyne circuit. That is, if interference is encountered at one point on the oscillator dial, it is often possible to shift to the repeat point and avoid it. With a single control arrangement, this is difficult, and sometimes impossible.

It is really surprising how the results are improved by the few circuit changes suggested. The new circuit is considerably easier to

handle than its predecessor, and the sensitivity is much improved.

From the schematic it can be seen that the sequence of the series filaments has been altered. The minus line starts at the first detector. From there, the wiring is continued through the first, second, and third I. F. stages and the second detector, then the oscillator and, finally, the first audio.

The main reason for this particular layout lies in the socket arrangement on the sub panel of the new model. The eight sockets are in one line, with the first detector at the extreme left, and the last audio at the right. The oscillator tube socket was placed between the first audio and the second detector. Therefore, in order to simplify the filament wiring to direct connections from one tube to the next in line, the filaments were wired exactly as shown in the schematic.

The list of parts, as used in the laboratory model of the revised receiver<sup>3</sup> is as follows:

- 1 Victoreen No. 150 coupling unit.
- 4 Victoreen No. 170 R. F. transformers.

- 2 Victoreen .0005 mfd. variable condensers.

- 1 Bodine DeLuxe loop.
- 8 Benjamin spring sockets for sub panel mounting.

- 2 Karas Harmonik audio transformers.
- 1 Hammarlund 11 plate midget variable condenser.

- 5 Tobe 1. mfd. bypass condensers.
- 2 Sangamo .00025 mfd. grid condensers, with clips.

- 1 Sangamo .001 mfd. fixed condenser.
- 2 Electrad gridleaks, 2 megohms.
- 2 Kurz-Kasch Aristocrat vernier port dials walnut.

- 1 Clarostat.
- 3 Carter 1,000 ohm potentiometers.
- 5 Union phone tip jacks.

- 1 Samson No. 125 R. F. choke.
- 1 Acme Celatsite battery cable.
- 50 ft. Acme Celatsite wire.

- 1 7 x 26 Lignole front panel, inlaid walnut.

- 1 7 x 24 Lignole sub panel.
- 1 Westinghouse Voltmeter, style NQ, 492418.

- 3 Benjamin adjustable sub panel mounting brackets.
- 1 Corbett type C cabinet.

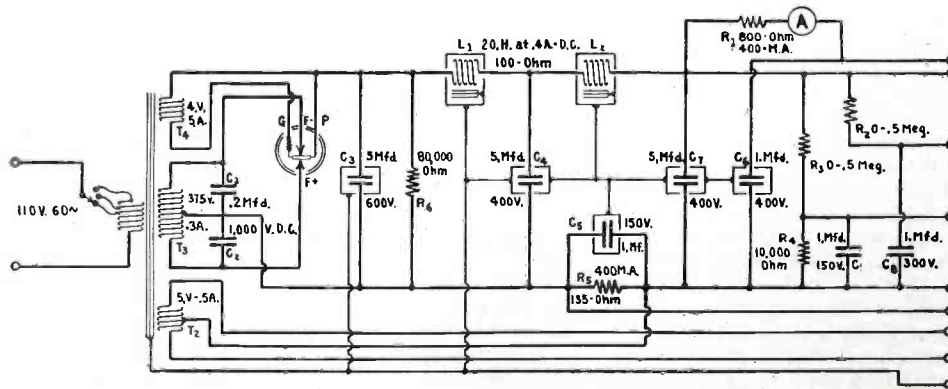

Circuit diagram of the unit for the new super-power rectifying tubes. This eliminator is intended for operation with a receiver using 201-AS, wired in series, such as the super-heterodyne shown in the diagram at the top of the page

---

# Super-Power Rectifiers

*Official circuit data and constants for an ABC eliminator using the new 300 milliamperere rectifiers*

---

**F**OR some time, vague rumors have circulated, throughout the radio industry, about new high powered rectifying tubes. Until very recently, however, nothing definite has come to light about these tubes.

Now the rumors have materialized into concrete form, for the Q. R. S. Music Company of Chicago has announced the perfection of such a tube. Dr. Charles Spaeth, an engineer of the company, spent two years in developing the device, and overcame a great many seemingly insurmountable difficulties.

Exhaustive tests have shown that the new rectifying tube is capable of supplying sufficient A, B, and C current to operate as many as ten 5 volt tubes. In the Q. R. S. plant in Chicago, seventy-five of the leading commercial receivers were tested and, in every case, the sets gave results when operating from the eliminator that were fully equal to those obtained when batteries were used.

In order to use the new eliminator, the tube filaments must be wired in series. However, this plan presents no drawbacks or disadvantages, for no practical difficulties are encountered with series filament wiring. As a matter of fact, series filaments have many advantages, and Radio Engineering has been advocating the system for months.

The schematic diagram illustrates the circuit of the new rectifier, and the constants are as follows:

The power transformer, composed of windings T 1, T 2, T 3, and T 4, is rated at 200 watts. T 1 is the primary winding, for 110 volts, 50-60 cycle, A.C. current, and is equipped with taps to compensate for different line voltages.

The secondary winding, T 2, furnishes the A, C, for a power tube, preferably of the 171 type. This winding delivers 5 volts at one half ampere, and is center tapped for the grid return.

T 3 is the high voltage secondary winding applied to the rectifier, and delivers 375 volts. This winding is also center tapped for the minus lead of the rectifier system.

T 4 is the low voltage secondary winding applied to the rectifier tube, and delivers 4 volts at 5 amperes.

L 1 and L 2 are filter choke coils. It is vitally important that these chokes possess the proper characteristics. They must have 20 henries inductance at 400 milliamperes D. C., and the D. C. resistance should not be over 100 ohms per coil.

C 1 and C 2 are buffer condensers placed across each half of the high voltage secondary. Each is of .2 mfd. capacity, and must be designed to

withstand 1,000 D. C. continuous working voltage.

C 3 is a 5. mfd. filter condenser, for 600 volts D. C. continuous working voltage; C 4 and C 5 are also 5. mfd., but are rated at only 400 volts D. C.; C 5 and C 9 are 1. mfd. condensers for 150 volts D. C.; and C 6 is a 1. mfd. for 400 volts D. C., while C 8 is a 1. mfd. for 300 D. C.

R 1 is a resistor of 800 ohms, with a current carrying capacity of 400 milliamperes. R 2 and R 3 are Charostats or Bradleyohms, ranging from 0-500,000 ohms. R 4 is a 10,000 ohm stabilizing resistance, and the bias re-

sistance R 5 is 135 ohms with current carrying capacity of 400 milliamperes. R 6 is a stabilizing resistance of 80,000 ohms. A is a 0-500 milliamperere D. C. milliammeter.

Several manufacturers are now at work designing special units for the new tube. Naturally, the requirements are more severe in this circuit than in a B eliminator, for instance. Particularly does this apply to the resistances, the power transformer, and the choke coils.

In conclusion, it is safe to say that, if the filaments are to be energized by D. C., and B and C power are to be obtained from the same source, series wiring of the filaments presents the only practical solution to full A, C, operation. As is well known, it is far easier to filter small currents at high voltages than it is to smooth large currents at low voltages, and series filament wiring follows as a matter of course.

---

## The Dill Bill

*Full text of the new legislation regulating radio communication*

---

**T**HE committee of conference on the disagreeing votes of the two Houses on the amendment of the Senate to the bill (H. R. 9971) for the regulation of radio communications and for other purposes, having met, after full and free conference, have agreed to recommend and do recommend to their respective Houses as follows:

That the House recede from its disagreement to the amendment of the Senate and agree to the same with an amendment as follows:

In lieu of the matter proposed to be inserted by said Senate amendment insert the following:

That this act is intended to regulate all forms of interstate and foreign radio transmissions and communications within the United States, its Territories and possessions; to maintain the control of the United States over all the channels of interstate and foreign radio transmission; and to provide for the use of such channels, but not the ownership thereof, by individuals, firms, or corporations, for limited periods of time, under licenses granted by Federal authority, and no such license shall be construed to create any right, beyond the terms, conditions, and periods of the license. That no person, firm, company, or corporation shall use or operate any apparatus for the transmission of energy or communications or signals by radio (a) from one place in any Territory or possession of the United States or in the District of Columbia to another place in the same Territory, possession, or District; or (b) from any State, Territory, or possession of the United States, or from the District of Colum-

bia to any other State, Territory, or possession of the United States; or (c) from any place in any State, Territory, or possession of the United States, or in the District of Columbia, to any place in any foreign country or to any vessel; or (d) within any State when the effects of such use extend beyond the borders of said State, or when interference is caused by such use or operation with the transmission of such energy, communications, or signals from within said State to any place beyond its borders, or from any place beyond its borders to any place within said State, or with the transmission or reception of such energy, communications, or signals from and/or to places beyond the borders of said State; or (e) upon any vessel of the United States; or (f) upon any aircraft or other mobile stations within the United States, except under and in accordance with this act and with a license in that behalf granted under the provisions of this act.

Sec. 2. For the purposes of this act, the United States is divided into five zones, as follows: The first zone shall embrace the States of Maine, New Hampshire, Vermont, Massachusetts, Connecticut, Rhode Island, New York, New Jersey, Delaware, Maryland, the District of Columbia, Porto Rico, and the Virgin Islands; the second zone shall embrace the States of Pennsylvania, Virginia, West Virginia, Ohio, Michigan, and Kentucky; the third zone shall embrace the States of North Carolina, South Carolina, Georgia, Florida, Alabama, Tennessee, Mississippi, Arkansas, Louisiana, Texas, and Oklahoma; the fourth zone shall embrace the States of Indiana, Illinois,

Wisconsin, Minnesota, North Dakota, South Dakota, Iowa, Nebraska, Kansas, and Missouri; and the fifth zone shall embrace the States of Montana, Idaho, Wyoming, Colorado, New Mexico, Arizona, Utah, Nevada, Washington, Oregon, California, the Territory of Hawaii, and Alaska.

Sec. 3 That a commission is hereby created and established to be known as the Federal Radio Commission, hereinafter referred to as the commission, which shall be composed of five commissioners appointed by the President, by and with the advice and consent of the Senate, and one of whom the President shall designate as chairman: Provided, That chairmen thereafter elected shall be chosen by the commission itself.

Each member of the commission shall be a citizen of the United States and an actual resident citizen of a State within the zone from which appointed at the time of said appointment. Not more than one commissioner shall be appointed from any zone. No member of the commission shall be financially interested in the manufacture or sale of radio apparatus or in the transmission or operation of radiotelegraphy, radiotelephony, or radio broadcasting. Not more than three commissioners shall be members of the same political party.

The first commissioners shall be appointed for the terms of two, three, four, five, and six years, respectively, from the date of the taking effect of this act, the term of each to be designated by the President, but their successors shall be appointed for terms of six years, except that any person chosen to fill a vacancy shall be appointed only for the unexpired term of the commissioner whom he shall succeed.

The first meeting of the commission shall be held in the city of Washington at such time and place as the chairman of the commission may fix. The commission shall convene thereafter at such times and places as a majority of the commission may determine, or upon call of the chairman thereof.

The commission may appoint a secretary and such clerks, special counsel, experts, examiners, and other employees as it may from time to time find necessary for the proper performance of its duties and as from time to time may be appropriated for by Congress.

The commission shall have an official seal and shall annually make a full report of its operations to the Congress.

The members of the commission shall receive a compensation of \$10,000 for the first year of their service, said year to date from the first meeting of said commission, and thereafter a compensation of \$30 per day for each day's attendance upon sessions of the commission or while engaged upon work of the commission and while traveling to and from such sessions, and also their necessary traveling expenses.

Sec. 4. Except as otherwise provided in this act, the commission, from time

to time, as public convenience, interest, or necessity requires, shall—

(a) Classify radio stations;

(b) Prescribe the nature of the service to be rendered by each class of licensed stations and each station within any class;

(c) Assign bands of frequencies or wave lengths to the various classes of stations, and assign frequencies or wave lengths for each individual station and determine the power which each station shall use and the time during which it may operate;

(d) Determine the location of classes of stations or individual stations;

(e) Regulate the kind of apparatus to be used with respect to its external effects and the purity and sharpness of the emissions from each station and from the apparatus therein;

(f) Make such regulations not inconsistent with law as it may deem necessary to prevent interference between stations and to carry out the provisions of this act: Provided, however, that changes in the wave lengths, authorized power, in the character of emitted signals, or in the times of operation of any station, shall not be made without the consent of the station licensee unless, in the judgment of the commission, such changes will promote public convenience or interest or will serve public necessity or the provisions of this act will be more fully complied with;

(g) Have authority to establish areas or zones to be served by any station;

(h) Have authority to make special regulations applicable to radio stations engaged in chain broadcasting;

(i) Have authority to make general rules and regulations requiring stations to keep such records of programs, transmissions of energy, communications, or signals as it may deem desirable;

(j) Have authority to exclude from the requirements of any regulations in whole or in part any radio station upon railroad rolling stock, or to modify such regulations in its discretion;

(k) Have authority to hold hearings, summon witnesses, administer oaths, compel the production of books, documents, and papers and to make such investigations as may be necessary in the performance of its duties. The commission may make such expenditures (including expenditures for rent and personal services at the seat of government and elsewhere, for law books, periodicals, and books of reference, and for printing and binding) as may be necessary for the execution of the functions vested in the commission and, as from time to time may be appropriated for by Congress. All expenditures of the commission shall be allowed and paid upon the presentation of itemized vouchers therefor approved by the chairman.

Sec. 5. From and after one year after the first meeting of the commission created by this act, all the powers and authority vested in the commission

under the terms of this act, except as to the revocation of licenses, shall be vested in and exercised by the Secretary of Commerce; except that thereafter the commission shall have power and jurisdiction to act upon and determine any and all matters brought before it under the terms of this section.

It shall also be the duty of the Secretary of Commerce—

(A) For and during a period of one year from the first meeting of the commission created by this act, to immediately refer to the commission all applications for station licenses or for the renewal or modification of existing station licenses.

(B) From and after one year from the first meeting of the commission created by this act, to refer to the commission for its action any application for a station license or for the renewal or modification of any existing station license as to the granting of which dispute, controversy, or conflict arises or against the granting of which protest is filed within 10 days after the date of filing said application by any party in interest and any application as to which such reference is requested by the applicant at the time of filing said application.

(C) To prescribe the qualifications of station operators, to classify them according to the duties to be performed, to fix the forms of such licenses, and to issue them to such persons as he finds qualified.

(D) To suspend the license of any operator for a period not exceeding two years upon proof sufficient to satisfy him that the licensee (a) has violated any provision of any act or treaty binding on the United States which the Secretary of Commerce or the commission is authorized by this act to administer or by any regulation made by the commission or the Secretary of Commerce under any such act or treaty; or (b) has failed to carry out the lawful orders of the master of the vessel on which he is employed; or (c) has willfully damaged or permitted radio apparatus to be damaged; or (d) has transmitted superfluous radio communication or signals or radio communications containing profane or obscene words or language; or (e) has willfully or maliciously interfered with any other radio communications or signals.

(E) To inspect all transmitting apparatus to ascertain whether in construction and operation it conforms to the requirements of this act, the rules and regulations of the licensing authority, and the license under which it is constructed or operated.

(F) To report to the commission from time to time any violations of this act, the rules, regulations, or orders of the commission, or of the terms or conditions of any license.

(G) To designate call letters of all stations.

(H) To cause to be published such call letters and such other announcements and data as in his judgment may be required for the efficient opera-

tion of radio stations subject to the jurisdiction of the United States and for the proper enforcement of this act.

The Secretary may refer to the commission at any time any matter the determination of which is vested in him by the terms of this act.

Any person, firm, company, or corporation, any State or political division thereof aggrieved or whose interests are adversely affected by any decision, determination, or regulation of the Secretary of Commerce may appeal therefrom to the commission by filing with the Secretary of Commerce notice of such appeal within thirty days after such decision or determination or promulgation of such regulation. All papers, documents, and other records pertaining to such application on file with the Secretary shall thereupon be transferred by him to the commission. The commission shall hear such appeal *de novo* under such rules and regulations as it may determine.

Decisions by the commission as to matters so appealed and as to all other matters over which it has jurisdiction shall be final, subject to the right of appeal herein given.

No station license shall be granted by the commission or the Secretary of Commerce until the applicant therefor shall have signed a waiver of any claim to the use of any particular frequency or wave length or of the ether as against the regulatory power of the United States because of the previous use of the same, whether by license or otherwise.

Sec. 6. Radio stations belonging to and operated by the United States shall not be subject to the provisions of sections 1, 4, and 5 of this act. All such Government stations shall use such frequencies or wave lengths as shall be assigned to each class by the President. All such stations, except stations on board naval and other Government vessels while at sea or beyond the limits of the continental United States, when transmitting any radio communication or signal other than a communication or signal relating to Government business shall conform to such rules and regulations designed to prevent interference with other radio stations and the rights of others as the licensing authority may prescribe. Upon proclamation by the President that there exists war or a threat of war or a state of public peril or disaster or other national emergency, or in order to preserve the neutrality of the United States, the President may suspend or amend, for such time as he may see fit, the rules and regulations applicable to any or all stations within the jurisdiction of the United States as prescribed by the licensing authority, and may cause the closing of any station for radio communication and the removal therefrom of its apparatus and equipment, or he may authorize the use or control of any such station and/or its apparatus and equipment by any department of the Government under such regulations as he may prescribe, upon just com-

ensation to the owners. Radio stations on board vessels of the United States Shipping Board or the United States Shipping Board Emergency Fleet Corporation or the Inland and Coastwise Waterways Service shall be subject to the provisions of this act.

Sec. 7. The President shall ascertain the just compensation for such use or control and certify the amount ascertained to Congress for appropriation and payment to the person entitled thereto. If the amount so certified is unsatisfactory to the person entitled thereto, such person shall be paid only 75 per centum of the amount and shall be entitled to sue the United States to recover such further sum as added to such payment of 75 per centum which will make such amount as will be just compensation for the use and control. Such suit shall be brought in the manner provided by paragraph 20 of section 24, or by section 145 of the Judicial Code, as amended.

Sec. 8. All stations owned and operated by the United States, except mobile stations of the Army of the United States, and all other stations on land and sea, shall have special call letters designated by the Secretary of Commerce.

Section 1 of this act shall not apply to any person, firm, company, or corporation sending radio communications or signals on a foreign ship while the same is within the jurisdiction of the United States, but such communications or signals shall be transmitted only in accordance with such regulations designed to prevent interference as may be promulgated under the authority of this act.

Sec. 9. The licensing authority, if public convenience, interest, or necessity will be served thereby, subject to the limitations of this act, shall grant to any applicant therefor a station license provided for by this act.

In considering applications for licenses and renewals of licenses, when and in so far as there is a demand for the same, the licensing authority shall make such a distribution of licenses, bands of frequency or wave lengths, periods of time for operation, and of power among the different States and communities as to give fair, efficient, and equitable radio service to each of the same.

No license granted for the operation of a broadcasting station shall be for a longer term than three years and no license so granted for any other class of station shall be for a longer term than five years, and any license granted may be revoked as hereinafter provided. Upon the expiration of any license, upon application therefor, a renewal of such license may be granted from time to time for a term not to exceed three years in the case of broadcasting licenses and not to exceed five years in the case of other licenses.

No renewal of an existing station license shall be granted more than thirty days prior to the expiration of the original license.

Sec. 10. The licensing authority may

grant station licenses only upon written application therefor addressed to it. All applications shall be filed with the Secretary of Commerce. All such applications shall set forth such facts as the licensing authority by regulation may prescribe as to the citizenship, character, and financial, technical, and other qualifications of the applicant to operate the station; the ownership and location of the proposed station and of the stations, if any, with which it is proposed to communicate; the frequencies or wave lengths and the power desired to be used; the hours of the day or other periods of time during which it is proposed to operate the station; the purposes for which the station is to be used; and such other information as it may require. The licensing authority at any time after the filing of such original application and during the term of any such license may require from an applicant or licensee further written statements of fact to enable it to determine whether such original application should be granted or denied or such license revoked. Such application and/or such statement of fact shall be signed by the applicant and/or licensee under oath or affirmation.

The licensing authority in granting any license for a station intended or used for commercial communication between the United States or any Territory or possession, continental or insular, subject to the jurisdiction of the United States, and any foreign country, may impose any terms, conditions, or restrictions authorized to be imposed with respect to submarine-cable licenses by section 2 of an act entitled "An act relating to the landing and the operation of submarine cables in the United States," approved May 24, 1921.

Sec. 11. If upon examination of any application for a station license or for the renewal or modification of a station license the licensing authority shall determine that public interest, convenience, or necessity would be served by the granting thereof, it shall authorize the issuance, renewal, or modification thereof in accordance with said finding. In the event the licensing authority upon examination of any such application does not reach such decision with respect thereto, it shall notify the applicant thereof, shall fix and give notice of a time and place for hearing thereon, and shall afford such applicant an opportunity to be heard under such rules and regulations as it may prescribe.

Such station licenses as the licensing authority may grant shall be in such general form as it may prescribe, but each license shall contain, in addition to other provisions, a statement of the following conditions to which such license shall be subject:

(A) The station license shall not vest in the licensee any right to operate the station nor any right in the use of the frequencies or wave length designated in the license beyond the term thereof nor in any other manner

than authorized therein.

(B) Neither the license nor the right granted thereunder shall be assigned or otherwise transferred in violation of this act.

(C) Every license issued under this act shall be subject in terms to the right of use or control conferred by section 6 hereof.

In cases of emergency arising during the period of one year from and after the first meeting of the commission created hereby, or on applications filed during said time for temporary changes in terms of licenses when the commission is not in session and prompt action is deemed necessary, the Secretary of Commerce shall have authority to exercise the powers and duties of the commission, except as to revocation of licenses, but all such exercise of powers shall be promptly reported to the members of the commission, and any action by the Secretary authorized under this paragraph shall continue in force and have effect only until such time as the commission shall act thereon.

Sec. 12. The station license required hereby shall not be granted to, or after the granting thereof such license shall not be transferred in any manner, either voluntarily or involuntarily, to (a) any alien or the representative of any alien; (b) to any foreign government, or the representative thereof; (c) to any company, corporation, or association organized under the laws of any foreign government; (d) to any company, corporation, or association of which any officer or director is an alien, or of which more than one-fifth of the capital stock may be voted by aliens or their representatives or by a foreign government or representative thereof, or by any company, corporation, or association organized under the laws of a foreign country.

The station license required hereby, the frequencies or wave length or lengths authorized to be used by the licensee, and the rights therein granted shall not be transferred, assigned, or in any manner, either voluntarily or involuntarily, disposed of to any person, firm, company, or corporation without the consent in writing of the licensing authority.

Sec. 13. The licensing authority is hereby directed to refuse a station license and/or the permit hereinafter required for the construction of a station to any person, firm, company, or corporation, or any subsidiary thereof, which has been finally adjudged guilty by a Federal court of unlawfully monopolizing or attempting unlawfully to monopolize, after this act takes effect, radio communication, directly or indirectly, through the control of the manufacture or sale of radio apparatus, through exclusive traffic arrangements, or by any other means or to have been using unfair methods of competition. The granting of a license shall not estop the United States or any person aggrieved from proceeding against such person, firm, company, or corporation for violating the law

against unfair methods of competition or for a violation of the law against unlawful restraints and monopolies and/or combinations, contracts, or agreements in restraint of trade, or from instituting proceedings for the dissolution of such firm, company, or corporation.

Sec. 14. Any station license shall be revocable by the commission for false statements either in the application or in the statement of fact which may be required by section 10 hereof, or because of conditions revealed by such statements of fact as may be required from time to time which would warrant the licensing authority in refusing to grant a license on an original application, or for failure to operate substantially as set forth in the license, for violation of or failure to observe any of the restrictions and conditions of this act, or of any regulation of the licensing authority authorized by this act or by a treaty ratified by the United States, or whenever the Interstate Commerce Commission, or any other Federal body in the exercise of authority conferred upon it by law, shall find and shall certify to the commission that any licensee bound so to do, has failed to provide reasonable facilities for the transmission of radio communications, or that any licensee has made any unjust and unreasonable charge, or has been guilty of any discrimination, either as to charge or as to service or has made or prescribed any unjust and unreasonable classification, regulation, or practice with respect to the transmission of radio communications or service: Provided, That no such order of revocation shall take effect until thirty days' notice in writing thereof, stating the cause for the proposed revocation, has been given to the parties known by the commission to be interested in such license. Any person in interest aggrieved by said order may make written application to the commission at any time within said thirty days for a hearing upon such order, and upon the filing of such written application said order of revocation shall stand suspended until the conclusion of the hearing herein directed. Notice in writing of said hearing shall be given by the commission to all the parties known to it to be interested in such license twenty days prior to the time of said hearing. Said hearing shall be conducted under such rules and in such manner as the commission may prescribe. Upon the conclusion hereof the commission may affirm, modify, or revoke said orders of revocation.

Sec. 15. All laws of the United States relating to unlawful restraints and monopolies and to combinations, contracts, or agreements in restraint of trade are hereby declared to be applicable to the manufacture and sale of and to trade in radio apparatus and devices entering into or affecting interstate or foreign commerce and to interstate or foreign radio communications. Whenever in any suit, action, or proceeding, civil or criminal, brought

under the provisions of any of said laws or in any proceedings brought to enforce or to review findings and orders of the Federal Trade Commission or other governmental agency in respect of any matters as to which said commission or other governmental agency is by law authorized to act, any licensee shall be found guilty of the violation of the provisions of such laws or any of them, the court, in addition to the penalties imposed by said laws, may adjudge, order, and/or decree that the license of such licensee shall, as of the date the decree or judgment becomes finally effective or as of such other date as the said decree shall fix, be revoked and that all rights under such license shall thereupon cease: Provided, however, That such licensee shall have the same right of appeal or review as is provided by law in respect of other decrees and judgments of said court.

Sec. 16. Any applicant for a construction permit, for a station license, or for the renewal or modification of an existing station license whose application is refused by the licensing authority shall have the right to appeal from said decision to the Court of Appeals of the District of Columbia; and any licensee whose license is revoked by the commission shall have the right to appeal from such decision of revocation to said Court of Appeals of the District of Columbia or to the district court of the United States in which the apparatus licensed is operated, by filing with said court, within twenty days after the decision complained of is effective, notice in writing of said appeal and of the reasons therefor.

The licensing authority from whose decision an appeal is taken shall be notified of said appeal by service upon it, prior to the filing thereof, of a certified copy of said appeal and of the reasons therefor. Within twenty days after the filing of said appeal the licensing authority shall file with the court the originals or certified copies of all papers and evidence presented to it upon the original application for a permit or license or in the hearing upon said order of revocation, and also a like copy of its decision thereon and a full statement in writing of the facts and the grounds for its decision as found and given by it. Within twenty days after the filing of said statement by the licensing authority either party may give notice to the court of his desire to adduce additional evidence. Said notice shall be in the form of a verified petition stating the nature and character of said additional evidence, and the court may thereupon order such evidence to be taken in such manner and upon such terms and conditions as it may deem proper.

At the earliest convenient time the court shall hear, review, and determine the appeal upon said record and evidence, and may alter or revise the decision appealed from and enter such judgment as to it may seem just. The revision by the court shall be con-

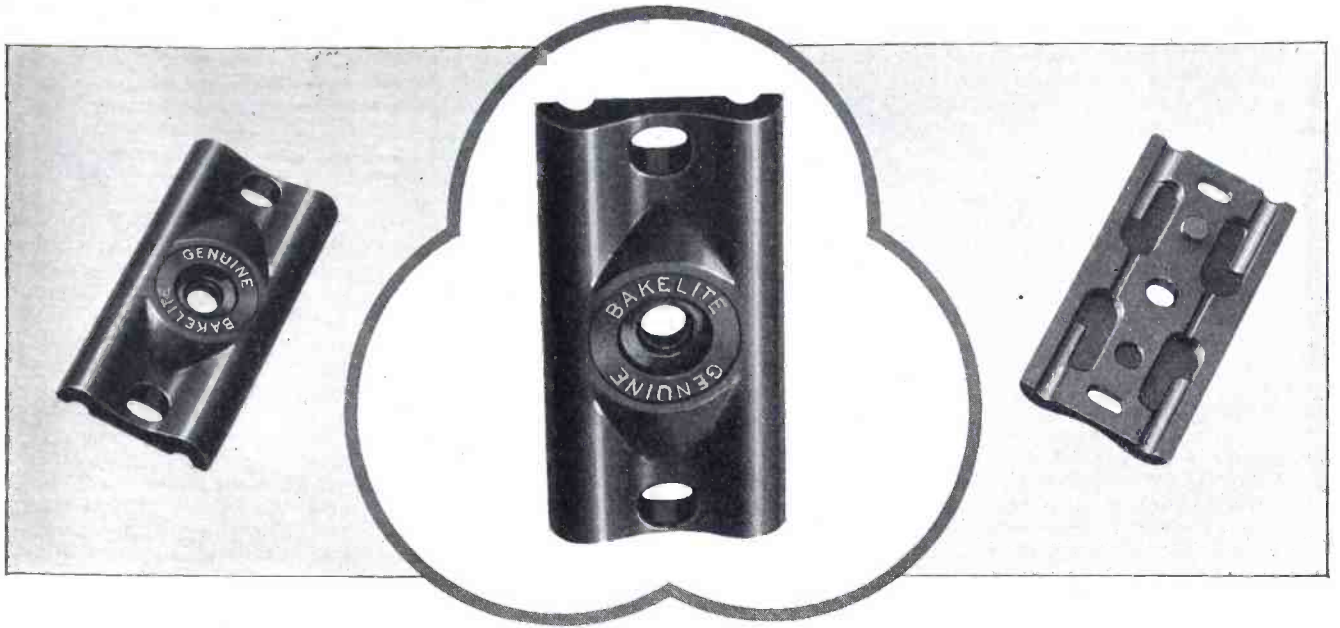

*Bakelite molded cover for Sparks-Withington connector  
Made by Sparks-Withington Co., Jackson, Mich.*

## **BAKELITE**

*—a trade-mark that will protect  
manufacturer, dealer and consumer*

There is no chance for the substitution of inferior materials when radio parts are marked "Bakelite"—for it is a trade-mark that only those who are using the genuine material are allowed to use.

By insisting upon the use of the trade-mark "Bakelite", manufacturers are assured of molded parts of uniform quality, color and lustre. Through the use of this trade-mark the dealer is protected against imitation products, and the consumer may accept parts so marked with confidence in their genuineness.

Bakelite engineers and research laboratories are always ready to cooperate with radio manufacturers in adapting Bakelite to their own particular needs.

*Write for Booklet 38*

### **BAKELITE CORPORATION**

247 Park Ave., New York, N.Y. Chicago Office, 636 W. 22nd St.

**BAKELITE CORPORATION OF CANADA, LTD.**, 163 Dufferin St., Toronto, Ont.

# BAKELITE

REGISTERED

U. S. PAT. OFF



THE MATERIAL OF A THOUSAND USES

"The registered Trade Mark and Symbol shown above may be used only on products made from materials manufactured by Bakelite Corporation. Under the capital "B" is the numerical sign for infinity, or unlimited quantity. It symbolizes the infinite number of present and future uses of Bakelite Corporation's products."

ined to the points set forth in the reasons of appeal.

Sec. 17. After the passage of this act no person, firm, company, or corporation now or hereafter directly or indirectly through any subsidiary, associated, or affiliated person, firm, company, corporation, or agent, or otherwise, in the business of transmitting and/or receiving for hire energy, communications, or signals by radio in accordance with the terms of the license issued under this act, shall by purchase, lease, construction, or otherwise, directly or indirectly, acquire, own, control, or operate any cable or wire telegraph or telephone line or system between any place in any State, Territory, or possession of the United States or in the District of Columbia, and any place in any foreign country, or shall acquire, own, or control any part of the stock or other capital share of any interest in the physical property and/or other assets of any such cable, wire, telegraph, or telephone line or system, if in either case the purpose is and/or the effect thereof may be to substantially lessen competition or to restrain commerce between any place in any State, Territory, or possession of the United States or in the District of Columbia and any place in any foreign country, or unlawfully to create monopoly in any line of commerce; nor shall any person, firm, company, or corporation now or hereafter engaged directly or indirectly through any subsidiary, associated, or affiliated person, company, corporation, or agent, or otherwise, in the business of transmitting and/or receiving for hire messages by any cable, wire, telegraph, or telephone line or system (a) between any place in any State, Territory, or possession of the United States or in the District of Columbia, and any place in any other State, Territory, or possession of the United States; or (b) between any place in any State, Territory, or possession of the United States, or the District of Columbia, and any place in any foreign country, by purchase, lease, construction, or otherwise, directly or indirectly acquire, own, control, or operate any station or the apparatus therein, or any system for transmitting and/or receiving radio communications or signals between any place in any State, Territory, or possession of the United States or in the District of Columbia, and any place in any foreign country, or shall acquire, own, control, or operate any part of the stock or other capital share or any interest in the physical property and/or other assets of any such radio station, apparatus, or system, if in either case the purpose is and/or the effect thereof may be to substantially lessen competition or to restrain commerce between any place in any State, Territory, or possession of the United States or in the District of Columbia, and any place in any foreign country, or unlawfully to create monopoly in any line of commerce.

Sec. 18. If any licensee shall permit any person who is a legally qualified

candidate for any public office to use a broadcasting station, he shall afford equal opportunities to all other such candidates for that office in the use of such broadcasting station, and the licensing authority shall make rules and regulations to carry this provision into effect: Provided, That such licensee shall have no power of censorship over the material broadcast under the provisions of this paragraph. No obligation is hereby imposed upon any licensee to allow the use of its station by any such candidate.

Sec. 19. All matter broadcast by any radio station for which service, money, or any other valuable consideration is directly or indirectly paid, or promised to or charged or accepted by, the station so broadcasting, from any person, firm, company, or corporation, shall, at the time the same is so broadcast, be announced as paid for or furnished, as the case may be, by such person, firm, company, or corporation.

Sec. 20. The actual operation of all transmitting apparatus in any radio station for which a station license is required by this act shall be carried on only by a person holding an operator's license issued hereunder. No person shall operate any such apparatus in such station except under and in accordance with an operator's license issued to him by the Secretary of Commerce.

Sec. 21. No license shall be issued under the authority of this act for the operation of any station the construction of which is begun or is continued after this act takes effect, unless a permit for its construction has been granted by the licensing authority upon written application therefor. The licensing authority may grant such permit if public convenience, interest, or necessity will be served by the construction of the station. This application shall set forth such facts as the licensing authority by regulation may prescribe as to the citizenship, character, and the financial, technical, and other ability of the applicant to construct and operate the station, the ownership and location of the proposed station and of the station or stations with which it is proposed to communicate, the frequencies and wave length or wave lengths desired to be used, the hours of the day or other periods of time during which it is proposed to operate the station, the purpose for which the station is to be used, the type of transmitting apparatus to be used, the power to be used, the date upon which the station is expected to be completed and in operation, and such other information as the licensing authority may require. Such application shall be signed by the applicant under oath or affirmation.

Such permit for construction shall show specifically the earliest and latest dates between which the actual operation of such station is expected to begin, and shall provide that said permit will be automatically forfeited if the station is not ready for opera-

tion within the time specified or within such further time as the licensing authority may allow, unless prevented by causes not under the control of the grantee. The rights under any such permit shall not be assigned or otherwise transferred to any person, firm, company, or corporation without the approval of the licensing authority. A permit for construction shall not be required for Government stations, amateur stations, or stations upon mobile vessels, railroad rolling stock, or aircraft. Upon the completion of any station for the construction or continued construction for which a permit has been granted, and upon it being made to appear to the licensing authority that all the terms, conditions, and obligations set forth in the application and permit have been fully met, and that no cause or circumstance arising or first coming to the knowledge of the licensing authority since the granting of the permit would, in the judgment of the licensing authority, make the operation of such station against the public interest, the licensing authority shall issue a license to the lawful holder of said permit for the operation of said station. Said license shall conform generally to the terms of said permit.

Sec. 22. The licensing authority is authorized to designate from time to time radio stations the communications or signals of which, in its opinion, are liable to interfere with the transmission or reception of distress signals of ships. Such stations are required to keep a licensed radio operator listening in on the wave lengths designated for signals of distress and radio communications relating thereto during the entire period the transmitter of such station is in operation.

Sec. 23. Every radio station on shipboard shall be equipped to transmit radio communications or signals of distress on the frequency or wave length specified by the licensing authority, with apparatus capable of transmitting and receiving messages over a distance of at least 100 miles by day or night. When sending radio communications or signals of distress and radio communications relating thereto the transmitting set may be adjusted in such a manner as to produce a maximum of radiation irrespective of the amount of interference which may thus be caused.

All radio stations, including Government stations and stations on board foreign vessels when within the territorial waters of the United States, shall give absolute priority to radio communications or signals relating to ships in distress; shall cease all sending on frequencies or wave lengths which will interfere with hearing a radio communication or signal of distress, and, except when engaged in answering or aiding the ship in distress, shall refrain from sending any radio communications or signals until there is assurance of no interference.

*(To be concluded in April Radio Engineering)*

*Radio Engineering, March, 1927*

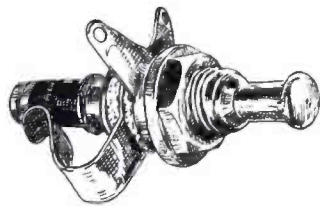

**PUSH PULL SWITCH**—fully guaranteed. Will stand high voltage. (Actual Size)



**THE SOCKET FOR MANUFACTURERS**

A new Saturn development which saves assembly time—decreases shipping weight. Costs less—AND IS ELECTRICALLY MORE EFFICIENT due to the minimum amount of metal used. Genuine bakelite—one or two hole mounting. Have you received samples?



**SHORT JACK No. 1**—one hole panel mounting—brass, nickel plated, phosphor bronze springs, fabric backed Bakelite insulation. (Actual Size)



**POWER TOGGLE SWITCH**—For power sets, Eliminators, Chargers. Compact, rugged. Quick make and break action. Und. Lab. Insp. 3A-125v=1A-250v. (Actual Size)

**“SATURN PRODUCTS FOR Better Connections”**

have, for years, been standard equipment for the leading set manufacturers.

*Samples and quotations on request*

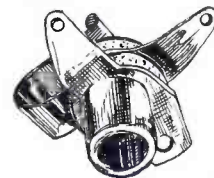

**SHORT JACK No. 1 F**—two hole panel or base mounting. (Actual Size)

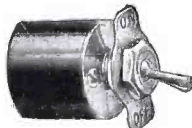

**TOGGLE SWITCH**—Double wiping contact—small—compact—cannot get out of order.

**The Saturn Mfg. and Sales Co., Inc.**  
48 Beekman St. - Dept. R.E. - New York, N. Y.

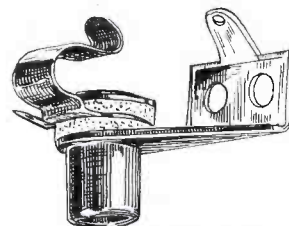

**SHORT JACK No. 1 B**—Base mounting with bracket support. (Actual Size)



**Engineering Instruments**

Radio engineers:—Your experimental and development work requires the use of accurate and reliable instruments for dependable results.

Jewell radio instruments are the standard of the Radio industry and are used the world over.

Our line of instruments is very complete with styles and types for every use.

Write us about your instrument requirements and ask us for a copy of our Radio instrument Catalogue No. 15-C.

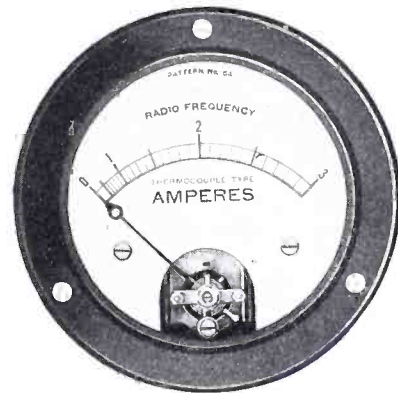

*Pattern No. 64*

Radio frequency Ammeter is a 3 inch diameter thermo couple type instrument. The thermo couples used are made from special non-oxidizing alloys guaranteed to stand 30% overload. The movement parts of the instrument are silvered and it is equipped with a zero adjuster. The scale is silver etched with black characters. Jewell instruments are handsome as well as accurate and rugged.

**Jewell Electrical Instrument Co.**

1650 Walnut Street -- Chicago

*“27 Years Making Good Instruments”*





# With the Manufacturers

Current news about the activities and plans of the radio manufacturers and concerns which make things used by the industry

## Precise

The Precise Manufacturing Company, 254 Mill St., Rochester, New York, is manufacturing several interesting items. The Precise Microdenser is a variable midget condenser made in various capacities. The 100 mmf. Microdenser is suitable for capacitatively coupling the antenna to the grid in broadcast receivers.

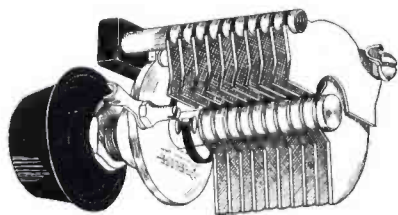

The Precise Microdenser finds many uses in various circuits.

The ganged condensers made by this company are ingeniously designed. They are equipped with mounting brackets for sub-panel mounting and the separate condensers are connected together with flexible couplers. These couplers are made in two ways. One has a bakelite disk which acts as an insulator, and the other has a phosphor bronze disk which connects all rotor shafts together.

## Acme Wire Company

Mr. Thomas B. Rhodes announced this week to the electrical and radio trade that the wound condenser formerly trade-marked 'SANGAMO' will now be known as 'PARVOLT'.

The Acme Wire Company, of New Haven, Connecticut, who furnished the condenser cartridge to the Sangamo Company will now manufacture the condenser in its entirety. Distribution plans on the condenser will not be altered.

This change also brings the Vice-Presidency of Rossiter and Company, New York, to Thomas B. Rhodes, who has been associated with Sangamo for the past 13 years.

This contact with the Sangamo Electric Company will not be completely broken as he will continue relations with both Sangamo and Acme Wire Company in reference to their advertising and publicity.

Mr. Rhodes takes with him to Rossiter the exclusive sales representation from Cleveland east for all Sangamo Radio products and the Parvolt Condenser.

This move is of particular interest as it marks the entrance of Mr. Rhodes, an executive with more than

24 years of experience in the electrical industry, into the radio business.

His new work will not be unfamiliar as he has been in charge of radio and radio development for the Sangamo Electric Company since they entered the field 3 years ago.

## Buckingham Radio Corporation

Roy T. Anderson, formerly of the Lincoln-Lily Advertising Agency of Chicago, has now become Vice-President and Sales Manager of the Buckingham Radio Corporation, 25 E. Austin, Chicago, Ill.

Mr. Anderson has been successfully associated in the advertising business for over eight years and his recent decision to enter the radio industry should prove even more beneficial to him, and to his business associates.

The Buckingham Radio Corporation, according to Mr. Anderson, is now making active plans for a larger national distribution on their extensive line of chassis, cabinets and one and two-dial receivers.



Mr. Roy T. Anderson, the new Vice-President of the Buckingham Radio Corporation

## Todd Electric Company

The Todd Electric Company, Inc., 36 W. 20th St., New York City, is manufacturing an A and B power unit.

The A battery is of the Alkaline Edison type, which will last indefinitely. The General Electric Trickle charger bulb is used.

The Rojas rectifier, which employs a new system of rectification, is used in the B circuit. Fourteen microfarads of condensers are employed in the filter

circuit, and these are guaranteed for a continuous working voltage of 750 D.C. Variable resistances control the output of the detector and radio frequency B voltage taps, so that the unit is adaptable to any receiver using up to and including six tubes.

## RCA Announces High Mu Tube

Because of the widespread interest of amateurs in resistance coupling a high mu tube especially designed with a view to providing high amplification, and suitable as a detector as well as an amplifier, is now announced by the Radio Corporation of America. This is the UX-240 Radiotron, which in general appearance and physical dimensions is similar to the well-known UX-201-A Radiotron.

The UX-240 Radiotron is a storage battery tube, with a one-quarter ampere, long-life filament of the thoriated tungsten type. A standard UX base is provided. This tube is intended to provide the highest practical voltage amplification so essential in resistance-coupled amplifiers. This method of amplification, in contrast with the transformer-coupled method, depends entirely upon the tube for the step-up effect. In transformer coupling, on the other hand, the step-up effect is brought about by the transformer ratio as well as the tube. Therefore Radiotron UX-240 has been designed to provide an amplification factor of 30.

The overall amplification of one stage of resistance coupling, employing the UX-240, is substantially equivalent to the average stage of transformer coupling employing the UX-201-A. This is contrary to general belief which holds that resistance-coupled circuits give such poor amplification that an additional stage or two are necessary to produce satisfactory volume. When a general purpose tube of moderate amplification is employed, this is admittedly the case. It may also be the case when tubes of a lower mu than 30 are employed. But with Radiotron UX-240 in the detector stage as well as in the first stage, there is adequate output to operate a power amplifier at full volume.

With the exceptional amplification factor (high mu) of the UX-240, it becomes possible for amateurs to reduce resistance-coupled amplification to two stages, namely, the first stage with this tube following the detector employing the same type tube, and the second stage with a Power Amplifier Radiotron. The cost of the condenser, plate coupling resistor, the grid leak employed in each resistance-coupled stage is only a fraction of the cost of the usual transformer.

Resistance-coupled circuits have heretofore been limited in popularity because of the high B-battery drain. This was true when the general purpose type tube was misapplied to resistance coupled circuits which call for a high mu tube. The "B" or plate

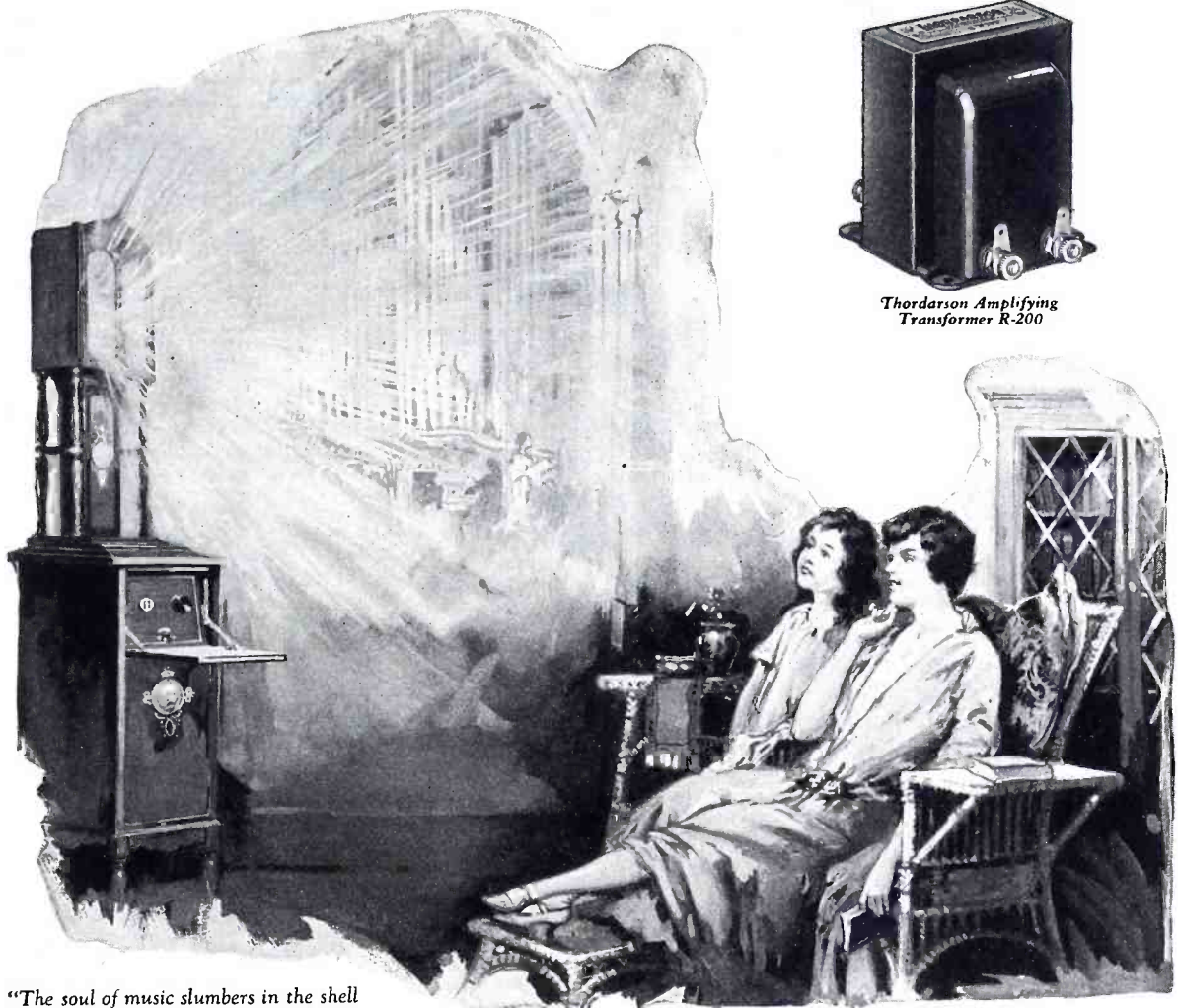

Thordarson Amplifying  
Transformer R-200

"The soul of music slumbers in the shell  
Till waked and kindled by the master's spell."  
(Samuel Rogers — "Human Life").

**W**ITHIN your set slumbers a world of music which you can charm to a living fullness and richness of tone by installing Thordarson Amplification.

The manufacturers of leading quality receivers have recognized in Thordarson Amplifying Transformers a fidelity of musical reproduction which removes the ordinary artificial tones of radio and replaces them with living harmonies.

Whether you are buying a complete receiver, or whether you are building your own—if you enjoy music—be sure that your transformers are Thordarsons.

# THORDARSON

RADIO TRANSFORMERS

*Supreme in Musical Performance!*

**THORDARSON ELECTRIC MANUFACTURING CO.**

*Transformer Specialists Since 1895*

**WORLD'S OLDEST AND LARGEST EXCLUSIVE TRANSFORMER MAKERS**  
*Huron and Kingsbury Streets — Chicago, Ill. U.S.A.*



current drawn by the UX-240, however, is about one-tenth that drawn by the average general purpose tube for the same purpose, even when operating at "B" voltages of 135 to 180 which are essential for proper results with resistance-coupling.

The characteristics of the UX-240 Radiotron are as follows.

Filament Voltage.....5.0 volts  
 Filament Current.... .25 amperes  
 Maximum Plate Voltage..180 volts  
 Recommended B Voltage..135-180 volts  
 Voltage Amplification Factor ( $\mu$ )  
 30  
 Plate Resistance....150,000 ohms  
 Plate Current at rated voltages.  
 .2 milliamperes

When employed in resistance-coupled amplification, the UX-240 should have a negative grid bias, which may be obtained from a "C" battery, to ensure freedom from distortion. Only the highest grade blocking condensers and resistances should be employed. The condensers must have high insulation resistance, while the resistances must be capable of withstanding the necessary current flow without deterioration. Otherwise, noisy reception may result sooner or later. The UX-240 itself is non-microphonic and otherwise free from noises.

The following values are recommended for resistance-coupled amplification with the UX-240:

Blocking Condensers...	.005-.05
microfarads	
Amplifier Grid Leaks	2 megohms.
"B" Plate Coupling "C"	
Voltage Resistance Voltage	
(Volts) (ohms) (Volts)	
180 250,000 -3	
135 250,000 -1.5	

Employed as a detector, the UX-240 Radiotron may be connected in the conventional manner with grid leak and grid leak condenser. The condenser should be of .00025 microfarads capacity, while the grid leak and plate coupling resistance are as follows:

"B" Plate Coupling "C"	
Voltage Resistance Grid Leak	
(Volts) (ohms) Values	
180 250,000 2-5 megohms	
135 250,000 2-5 megohms	

Where minimum of distortion is preferred rather than extreme sensitivity, a different detector circuit using a "C" battery instead of a grid leak and condenser is recommended. A common "C" battery for detector and amplifiers may be used, the "C" connection being similar in both instances. It will be noted, however, that a higher "C" voltage is used for detection.

"B" Plate Coupling "C"	
Voltage Resistance Voltage	
(Volts) (ohms) (Volts)	
180 250,000 -4.5	
135 250,000 -3	

With the appearance of the UX-240 Radiotron, it is confidently expected that resistance-coupling will become increasingly popular with amateurs.

## Rono

The Rono Manufacturing Company, 426 Clinton St., Chicago, makes a device known as the Rono Multi-stage Jack Filament Switch. This unit has seven terminals and, when correctly wired into the circuit, it switches the speaker from one to two stages of audio by a turn of the knob.

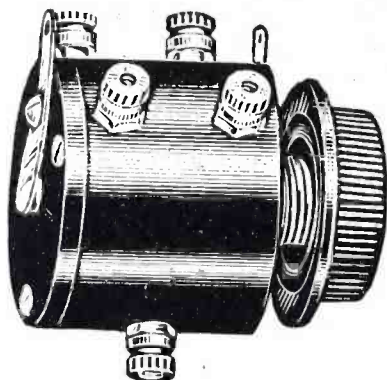

This Rono device takes the place of all jacks and switches ordinarily used in the audio stages

## Auto Vacuum Products Co.

The Auto Vacuum Products Company, 220 W. 42nd St., New York City, is manufacturing a new B eliminator, known as the Auto-B. The rectifying element used is the "recto-cell," which has successfully passed the rigid tests of technical authorities.

The unit contains a saline solution, which is harmless to rugs or clothing. The only attention required is the addition of distilled water once or twice a year. The device is designed to operate from 110 volts, 60 cycle, A.C. current, and supplies sufficient B potential for sets using up to ten tubes.



A harmless saline solution is used in the Auto B

## Jewell

The Jewell Electrical Instrument Company, 1650 Walnut St., Chicago, has recently started production upon a B eliminator tester. This device contains suitable high reading meters, and an adjustable control by which any desired load can be placed upon the eliminator under test. The amount of

current drain indicated on the milliammeter is controlled by the variable resistance and the high resistance volt-

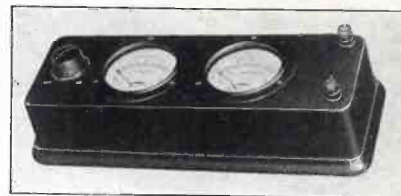

The Jewell B eliminator tester gives accurate readings on the output of plate supply units

meter gives the output voltage at the current draw shown. The connections to the instruments are such that the current drawn by the voltmeter is part of the actual load, and therefore very accurate readings are possible.

## Westerland

The Westerland Corporation, Dobbs Ferry, New York, makes the Westerland Tuning Dial and Station Finder. This dial can be instantly changed from coarse tuning to fine, and special indicators are provided so that the call letters of stations heard can be shown directly on the dial. The list price is \$2.50.



The Westerland Station Finder affords a choice of fine or coarse tuning

## Changes in Dubilier Organization

Mr. William Dubilier, Technical Director of Dubilier Condenser Corporation, who organized and has headed the company since its inception, is pleased to announce the election of Mr. Fred D. Williams as President and Director of Sales, effective as of February 15th. Mr. Dubilier has long felt the need of additional executive help in the corporation, so that he could devote his entire time to the development and refinement of Dubilier products.

The tremendous amount of research and development work required in this industry is important beyond the conception of those unfamiliar with the field and it is Mr. Dubilier's intention to have his corporation continue to step ahead of the require-

Audiophone Mfg. Corp. Henry Hyman & Co. C.M. Kramer &  
 Acme Electric Mfg. Co. Harbison & Gathright King Elec. Mf  
 All American Radio Co. Mallock & Watson Radio Kodel Radio C  
 American Apparatus Co. Holmes Jordan Radio Co. Kokomo Electr  
 Aurad Company Inc. Lombardi Radi  
 Bellack Co., C. Lane Mfg. Co.  
 Best Electric Co. Lang Mfg. Co.  
 Blood & Claus Langford Radi  
 Boston Radio Mf Martin, Glenn  
 L. S. Brick Mfg. Mayolian Radi  
 Columbia Univer Macky Co.  
 Consolidated Ba Modern Elec.  
 Cooper Corp. National Co.  
 Cunningham, Inc Peerless Radi  
 Chamberlain Ele Reichmann Co.  
 Curtis Elec. Co. Rollaway Moto  
 Davey Electric C Raala Elec. C  
 Dynamic Radio C Superb Electr.  
 Dongan Electric Silver Marsha  
 Electric Power C Stora Mfg. C  
 Elec. Service Er Sterling Mfg.  
 Englert Mfg. Co. Shore Elec. M  
 Elec. Heat Contr Thordarson El  
 Electrical Resea J-Flex Mfg. C  
 Edwards Battery Velvetone Rad  
 Forbend Electric Wedel Co.  
 Fleming Bell Mfg. Co. Webster Co.  
 Ford Radio & Mica Corp. Wagge Co.  
 Gary's Battery Service Jewell Electric Inst. J. Andrew Whi  
 Gossard Radio & Wire Co. Jordan Carisch Wright DeCost  
 General Radio Co. Jefferson Electric Mf Wolke Elec. C  
 Golden Lutz Corp. C. E. Jacobs Zenith Radio

# from A to Z

almost UNANIMOUS

AN overwhelming majority of the country's leading manufacturers, technicians and engineers recommend and use CLAROSTAT wherever a variable resistance is specified.

CLAROSTAT is time tested and tried—for ability to cover the entire range (from practically zero to 5,000,000 ohms)—for current carrying capacity (20 watts without packing, arcing or crackling noises) and for precision and dependability.

American Mechanical Labs. Inc. Brooklyn, N. Y.

## CLAROSTAT

**A word of caution!** While we feel highly flattered at the attempts of some unscrupulous manufacturers to imitate CLAROSTAT, we feel it our duty to emphasize the fact that the only similarity between the genuine and the poor imitations lies in the general design and shape. Play safe. Look for the name CLAROSTAT on the bottom.

## Does Any Line Encounter More Difficulties, Because of Improper Packing, Than the Radio Line?

*We can overcome your troubles, whether you ship large sets or small set—whether they weigh ten pounds or five hundred pounds.*

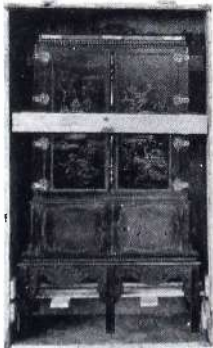

Our experience is at your command without obligation

**TIFFT BROS.**

Shipping cases for difficult problems.  
2 Broadway New York City.



## Good Radio Made Better by the Only Lock Washer of its Kind

MANY manufacturers say the Shakeproof Lock Washers and Locking Wire Terminals are the best good radio insurance they have ever bought. And it's what they say that counts.

Here are typical Shakeproof customers—Crosley, Fada, Erla, Freshman.

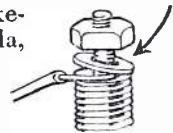

Shakeproof Lock Washers and Locking Terminals stop the most vicious of all troubles—loose connections resulting in poor reception.

### Test Shakeproof Without Cost

Your set—completely Shakeproof protected—will have tight connections, absolutely tight. Shakeproof is vibration proof. The more the vibration, the tighter those twisted teeth bite into the work. Think what that means in shipment. Bad bumps hurt good radio—and there's many a bump between your factory and final delivery to the home.

Operators prefer Shakeproof because it cannot be tangled.

Send—today—for ample and free quantity for your own shop test. That test will sell you, for all time, on Shakeproof superiorities, economies, improvements of work.

SHAKEPROOF LOCKING WIRE TERMINAL



Phosphor Bronze—Hot Tinned—In Sizes for Nos. 4, 6, 8 and 10 Radio Screws  
SHAKEPROOF LOCK WASHERS



Type 11 External



Type 12 Internal

Best Tempered Steel or Phosphor Bronze—For Standard Screw Sizes

**Shakeproof Lock Washer Company, Incorporated**

2507 North Keeler Ave.

Chicago, Ill.

ments of the trade in this highly specialized work. Mr. Williams is already well and favorably known to the entire manufacturing and distributing trade of the radio industry. His



Harry J. Houck, Chief Engineer, Dubilier Condenser Corporation

success with the Majestic B Battery Eliminator is universally known. In his new position he will be of considerable help to both manufacturers and distributors because of his definite knowledge of their problems gained through his close contact with them in the past.

Mr. Dubilier stated that at the present time the Company is in a better position, both from a financial and organization standpoint, than ever before in its history.

Mr. W. T. Smith, Vice-President of W. A. Harriman & Co., Inc., as Chairman of the Board of Directors, brings to the company a wealth of experience of industrial management and financial control which is invaluable.

Mr. T. C. Hammond, who continues as Vice-President and General Manager has had a wide experience in factory and organization management.

Mr. W. J. Smith will continue as Treasurer of the company.

Mr. C. H. Alvord, formerly associated with the American Bosch Magneto Company, as Superintendent of factory, will be in charge of production. Mr. Alvord is experienced in the manufacture of condensers, and his intensive study of condenser problems from a production standpoint makes him especially fitted for this position.

Assisting Mr. Dubilier in his research and development work will be Mr. Harry W. Houck, who has been appointed Chief Engineer of the company. Mr. Houck has been associated with Mr. Dubilier for the past six years, and is well known in radio

engineering circles, especially in developing the second harmonic principle (Super-Heterodyne) which he devised in collaboration with Mr. E. H. Armstrong for the Radio Corporation of America.

### Hahn President of Amrad

At a recent meeting of the Board of Directors of the Amrad Corporation located at Medford Hillside, Massachusetts, Major James E. Hahn was elected President. Major Hahn's activities in the radio industry are perhaps better known in Canada than in the States. Major Hahn is President of the DeForest Radio Corporation, Ltd., Toronto, Canada, in which Powel Crosley, Jr., President of The Crosley Radio Corporation in Cincinnati, is heavily interested. Major Hahn, during the comparatively few years of his activities in the radio industry, has built the DeForest Corporation, Ltd., Canada, to an outstanding position in the Dominion, having attained first position in number of sets sold there.

Major Hahn succeeds Harold J. Power as President of Amrad. Mr. Power's activities in the radio industry date back to the pioneer days before the war. He is withdrawing from Amrad, having sold his interest in the Corporation to Major Hahn, to engage in an independent radio business of his own.

### Splitdorf Bethlehem Electrical Company

Robert W. Porter, General sales manager of the Splitdorf Bethlehem Electrical Company, has been elected vice-president in Charge of Sales, it is announced by Walter Rautenstrauch, president of the company. At the last meeting of the Board of Directors, Mr. Rautenstrauch reported the results of a thorough canvass of the territory in which the Splitdorf

company is represented by 10,000 dealers, and stated that commitments on 1927 business were already in advance of 1926. He announced an annual saving of \$200,000 as the result of improved manufacturing methods which were recently introduced.



Fred D. Williams, President and Director of Sales, Dubilier Condenser Corporation

### Crosley

Powel Crosley, Jr., President of the Crosley Radio Corporation and his newly appointed assistant, Ralph H. Langley. Mr. Langley developed the first airplane transmitter several years ago and he is considered one of the leading scientists in the radio industry. In his new capacity Mr. Langley will be Mr. Crosley's technical advisor. For the past six years Mr. Langley has been in charge of receiving set development for the General Electric Company.



Powel Crosley, Jr., and Ralph H. Langley. Mr. Langley was formerly with the General Electric Co., and is now to direct the technical and engineering enterprises of the Crosley Radio Corporation

# WHY?

## UNION RADIO TIP JACKS

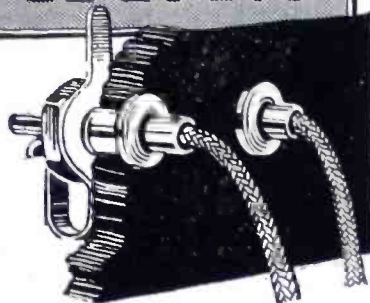

### Are Standard Equipment on the Finest Receiving Sets

1. They increase saleability of the set at a relatively small cost.
2. Radio buyers readily see their advantages over binding posts.
3. They insure positive contacts, and instant insertion or removal of cord tips.
4. Heavily nickel-plated and ingenious in design, they make every set more attractive.
5. The most up-to-date connections for battery leads, aeriels, ground wires, loud speaker, etc.

#### TO DEALERS

Union Radio Tip Jacks sell fast and profitably at 25c a pair. Feature this Item—fans need many pairs of jacks for input and output leads.

Firmly grip all wires from No. 11 to No. 24 B & S gauge. Three sizes for all panels. Type A (Standard) for 3/16" to 1/4" panels. Type B (Special) for panels, cabinet walls and partitions from 5/16" to 1/2" thick. Type C (Standard) for panels up to 3/8" thick. Packed in self-selling cartons of 1/12, 1/2 and 1 gross pairs.



#### IDENTIFICATION TAGS

Hard red fiber ovals marked with proper identifications of battery connections, such as A—, B—, B 67, B 90, etc. Prevent shorting battery or blowing tubes. Packed 100 in box of one designation only. Retail price \$1.00. Also in set of 9, retail price 10c.

#### TO ALL BRANCHES OF THE TRADE

Send for illustrated circular and samples of these fast selling radio products, and details of our attractive proposition.

**UNION RADIO CORPORATION**  
124 ~ SUSSEX ~ AVENUE, ~ NEWARK ~ N.J.  
NEW YORK OFFICE ~ 40-EAST-34<sup>TH</sup> ~ STREET.

# TOBE

Trade Mark Reg. U. S. Pat. Office

## CONDENSERS and B-BLOCKS



The first condenser B BLOCK, specifically designed for use with the Thordarson Power Compact Type R-171, is the TOBE B BLOCK Type R-171. The terminals are arranged so that they come close to those on the Thordarson Power Compact, for minimum time and length of wiring. Short-path, non-inductive condensers are used for increased efficiency. The price is \$12.00.

Thordarson makes a 210 unit, also, and there is the TOBE B BLOCK Type R-210 to go with it. Price, \$13.00

The National Power Amplifier uses TOBES throughout.



A 1-Mfd. TOBE By-Pass Condenser is specified for use with the

### OFFICIAL BROWNING - DRAKE KIT - SET

This embodies the latest and most advanced thought of Glenn H. Browning in the design and construction of the famous BROWNING-DRAKE Circuit. TOBE Condensers are used throughout. This is another substantial recognition of TOBE quality.

Send for Price List E-3

**Tobe Deutschmann Co.**

Engineers and Manufacturers of Technical Apparatus

Cambridge, Mass.

# Leading All Radio Fan Publications

The most sophisticated radio bugs have been amazed to find that there is as much truly new dope as is published monthly in Radio Mechanics, and the method in which it is presented has delighted them.

**RADIO MECHANICS MAGAZINE**

*Edited by M. B. SLEEPER*

*"The Fun of Radio Is  
in Doing It Yourself"*

Chicago, 307 N. Michigan Ave.

Phone, State, 6079

New York, 52 Vanderbilt Ave.

Phone, Vanderbilt, 2274



demand  
**AEROVOX**  
 "Built Better"  
**FILTER CONDENSER  
 BLOCKS**

for all "B" Eliminators  
 and Power Amplifiers  
 AEROVOX products are used as  
 standard equipment by over  
 200 manufacturers of Radio  
 Receivers and "B" Eliminators.

AEROVOX WIRELESS CORP. 60-72 Washington St., Brooklyn, N.Y.

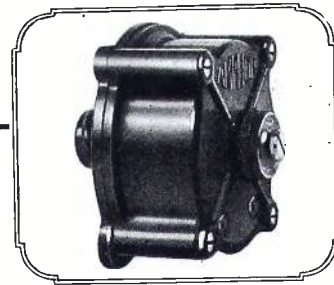

The Amplion unit helps any set to give its best performance.

Many set manufacturers  
 have accepted our offer  
 of cooperation—

Our engineering staff is at your service for all problems of enclosed units and matching unit to your set electrically.

We will be glad to discuss these matters with you at any time.

The Amplion Corporation of America  
 Suite W, 280 Madison Ave. New York City



Radio's Latest Improvement!

**RONO**  
 MULTI-STAGE JACK  
 and  
 FILAMENT SWITCH  
 Each . . . . . \$2.50



The Rono eliminates all jacks and push-pull plugs and attendant wiring and soldering. The Rono dial controls the batteries and both audio stages. Each stage a filament control. Single hole mounting—saves time, labor and cost. Absolutely efficient. Write for samples and descriptive material.

Manufacturers and Jobbers, communicate.

RONO MFG. CO., 426 So. Clinton St., Chicago, Ill.

**READY SOON**

Our engineers have been working steadily for many months to prepare the new United Scientific Laboratory line of radio products, which will be ready soon. It has been our purpose in the preparation of this new line of radio products, to meet the greatest demand with a dependable line that will give jobbers and dealers the opportunity to make bigger PROFITS with a quick turnover.

United Scientific Laboratories, Inc.  
 80 Fourth Ave. New York City

BRANCH OFFICES  
 St. Louis  
 Chicago  
 Boston  
 Minneapolis  
 Canadian Office:



BRANCH OFFICES  
 Cincinnati  
 Los Angeles  
 Philadelphia  
 San Francisco  
 London, Ontario

**Copper Shielding**

Gives better reception  
 —closer selectivity and  
 finer tone quality.

Sheet copper combines  
 higher conductivity  
 with easy working  
 qualities.

**COPPER & BRASS**  
 RESEARCH ASSOCIATION  
 25 Broadway — New York



## Why do Leaders use DURHAM'S?

When 17 of the largest and most important manufacturers of radio receivers use Durham Resistors exclusively there must be a very good reason.

500 ohms to 10 megohms



# DURHAM

METALLIZED

# RESISTORS

INTERNATIONAL RESISTANCE  
COMPANY

Dept. G, Perry Bldg., Philadelphia, Pa.

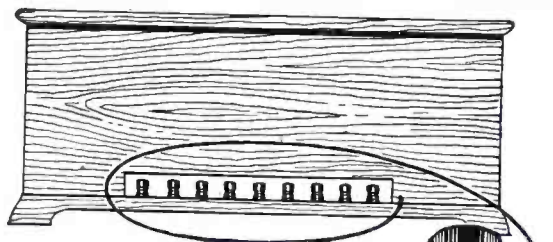

## The Contact Radio Relies On!

Wherever a sure, safe and fool-proof connection is necessary radio engineers rely upon EBY Binding Posts to do the job.

If you are building a famous circuit—Hammarlund-Roberts, Infradyne, Cockaday L.C. 27 or any one of many others you will find EBY Binding Posts specified. Likewise eight out of ten of the radio receivers manufactured are EBY equipped. Such acceptance is the result of experiments dating from the beginning of radio. We will gladly furnish complete information upon request.

The H. H. EBY MFG. CO., Inc., Philadelphia, Pa.

# EBY

## BINDING POSTS



## A NEW ADDITION

to our line—the TRUPHONIC Standard amplifier tube—a high-mu tube, capable of handling a heavier signal without loss of clarity and with an increase in volume.

Especially designed for the TRUPHONIC audio amplifier (an H. P. Donle development) and TRUPHONIC equipped sets.

**\$2.50**

THE DONLE-BRISTOL CORP.,

52 Cambridge St.,  
MERIDEN—CONN.



## Radio Engineers NEVER Guess —They Know!



Poly By-pass Condensers



Poly Fixed Condensers

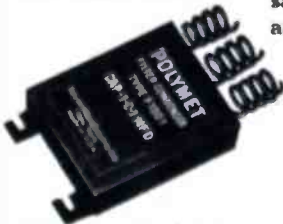

Poly Filter Condensers

That's why set manufacturer after set manufacturer — power unit builder after power unit builder, eventually turn to Polymet for condensers.

Polymet Condensers are proving their unqualified superiority every day in the laboratories of these manufacturers. And thousands of Polymet Condensers, embodied in sets and power units, in homes throughout the country, are standing out as primary factors in satisfactory, lasting performance.

*We will gladly send you catalog and complete information regarding Polymet Condensers and other Polymet Products on request.*

**Polymet Manufacturing Corporation**  
599 H Broadway New York City  
*"World's Largest Manufacturers of Radio Essentials"*

# POLYMET PRODUCTS

## USE THESE COILS AND IMPROVE ANY RADIO RECEIVER!

**AERO COIL**  
SUPER-SENSITIVE  
INDUCTANCE UNITS



**TUNED RADIO  
FREQUENCY KIT**  
\$12.00

The Aero Coil Tuned Radio Frequency Kit illustrated above will positively improve the performance of any receiver. Patented Aero Coil construction eliminates radio frequency losses and brings tremendous improvement in volume, tone and selectivity. Kit consists of three matched units. The antenna coupler has variable primary. Uses .00035 condenser. 8-page color circuit, layout and instruction sheet for building the super-sensitive 5-tube Aero-Dyne receiver packed FREE with each kit. Extra copies, 75c each. Instructions include insert showing how to wire up for a power tube if desired.

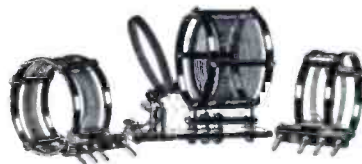

**LOW WAVE TUNER KIT**  
\$12.50

Completely interchangeable. Adapted by experts and amateurs. Range 15 to 130 meters. Includes three coils and base mounting, covering T. S. bands, 20, 40 and 80 meters. You can increase the range of this short wave tuner by securing coils Nos. 4 and 5. Combined range of 15 to 550 meters. Both interchangeable coils fit same base supplied with short wave kit and use the same condensers. Coil No. 4 price \$4.00; Coil No. 5 price \$4.00.

*Get these Coils from your nearest dealer. If he should be out of stock, order direct from the factory.*

**AERO PRODUCTS, INC.,**  
Dept. 17, 1772 Wilson Ave., Chicago, Ill.

## Testing of Radio Apparatus

We make a specialty of testing condensers at radio frequencies

**Electrical Testing Laboratories**

80th St. and East End Ave., New York City

## SHIELDING TERMINALS—ANGLES—DIES

METAL STAMPINGS TO ORDER



15

Our Battery of Automatic Presses assures quick service—economy in cost—engineering accuracy.

MAY WE QUOTE YOU ON YOUR WORK?



38

**F. R. ZIERICK MACHINE WORKS**

6-8 Howard St., Dept. R. E. New York City

### See That Screw

A screw-driver adjusts an X-L in crowded places



## X-L VARIO DENSER

RESULTS in easier tuning, more distance, volume and clarity—greater stability. Indorsed by leading authorities.

Model "N" A slight turn obtains correct tube oscillation on all tuned radio frequency circuits. Neutrodyne, Roberts two tube, Browning-Drake, McMurdo Silver's Knockout, etc., capacity range 1.8 to 20 micro-microfarads. Price \$1.00

Model "G" with grid clips obtains the proper grid capacity on Cockaday circuits, filter and intermediate frequency tuning in heterodyne and positive grid bias in all sets. Capacity range Model G-1 .00002 to .0001 M F D. Model G-5 .0001 to .0005 M F D. Model G-10 .0003 to .001 M F D. Details on request. Price \$1.50

X-L Push Post. Push it down with your thumb, insert wire, remove pressure and wire is firmly held. Releases instantly. Price 15c

Seven Push Post Panel permanently marked in white on black insulating panel. In box including soldering lugs, raising bushings and screws for mounting, etc. Price \$1.50

**X-L RADIO LABORATORIES** 2423 Lincoln Ave., CHICAGO, ILL.

## WIRE

STRAND—Antennae (plain or enameled)—Double Galvanized.  
WIRE—Antennae (plain or enameled) Connecting and Ground (Rubber) covered, braided or plain.  
BUS BAR—Litzendraht-Loop.  
MAGNET (Cotton or Silk).

**John A. Roebling Son's Co.**  
Trenton, N. J.

## LACQUERS

FOR THE

## RADIO INDUSTRY

**Egyptian Lacquer Co.**

Dept R. E.

90 West St., New York City



For PERFECT Filament Control

## AMPERITE

The "SELF-ADJUSTING" Rheostat

Simplifies set operation. Solves tube control problems. Avoids distortion in reception. Decreases servicing need. Lowers production costs. Write for details.

**Radiall Company**

50 Franklin St., New York, N. Y.

## Cardwell Condensers

"THE STANDARD OF COMPARISON"

81 Prospect Street, Brooklyn, New York



**MUCHER IS HEADQUARTERS** for Spring Binding Post Clips, Antenna Lead-ins, Ground Clamps, Spring Binding Post Strips, and allied specialties. Unexcelled facilities for manufacturing stamped parts for radio. Mucher is prompt on deliveries and right on costs.

**John J. Mucher, 109 Lafayette St., N. Y.**

# CARTER For all Circuits

new wire wound

## FIXED RESISTORS

HEAVY DUTY TYPE



Full Size

1/4 to 4 ohms

25c

For reducing 6 volt current to 5 volts for 201 type tubes

Same size available up to 1000 ohms for use as grid and plate resistors.

**Permanent      Accurate      Sturdy**

Resistors for B Eliminators and Power devices built to meet requirements.

**CARTER RADIO CO.**  
CHICAGO

In Canada  
Carter Radio Co.,  
Limited, Toronto

# VICTOREEN —

*A Super Set Without a Peer*

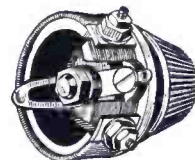

### Victoreen Rheostat

Zero temperature coefficient. Increased number of turns of wire. Three terminals simplifying wiring. Five resistances, 2, 6, 10, 20, 30 ohms, each \$1.20. Potentialities 200 or 400 ohms, each \$1.50.

### Victoreen

#### R. F. Transformers

Are especially recommended for their sharp tuning. They are actually tuned to a precision within 1/3 of 1% — a Victoreen feature.

Use No. 170 RF Transformers for regular tubes.

Use No. 171 RF Transformers for dry cell tubes.

Victoreen No. 150 coupling unit is made for use with these transformers.

Victoreen Super Sets are free from oscillation, howls or squeals. Ask your dealer or write to us for blue print and complete information.



### Master Control Unit

A one-dial unit with compensator permits adjustment up to 20 degrees variability, with a 360 degree vernier motion. Used in circuit employing 2 or more condensers of the same capacity.

Two condenser type—\$19.50. Extra condensers, each \$4.50.

**THE GEO. W. WALKER CO.,**

6528 Carnegie Ave., Dept. N. Cleveland, Ohio

Merchandisers of Victoreen Radio Products

## PHILADELPHIA

Chestnut and 39th Street

# Hotel Pennsylvania

Fireproof—Unrestricted Parking—Garage

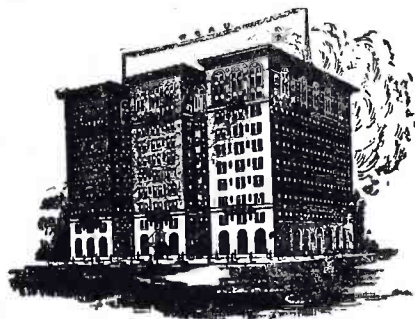

OSCAR W. RICHARDS, Manager

**600 ROOMS—500 BATHS**

Rooms with running water from \$2.50 per day

Rooms with private bath and shower from \$3.50 per day

*Food and Service the Best*

Near West Philadelphia Station Pennsylvania Railroad  
University of Pennsylvania—Franklin Field

# ELECTRAD

Insure Perfect  
Control of Volume

**ELECTRAD**

Royalty

Variable

High Resistances

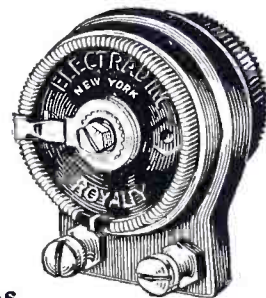

Tests have proven them to be the most accurate and dependable resistances for controlling tone and volume. That's why radio authorities insist on them. Note these superior features:

- 1—Resistance element is not exposed to any mechanical operation.
- 2—Electrical contact is made positive by metallic arm on wire-wound strip.
- 3—The same resistance is always obtained at the same point.
- 4—Resistance value is under control in process of manufacture and does not change in use.

A range for every purpose—11 in all.

Type E—\$2. All other types A-L \$1.50

Write for technical data.

175 Varick St., New York, N. Y.

# ELECTRAD

# Buyers Directory of Equipment and Apparatus

Readers interested in products not listed in these columns are invited to tell us of their wants, and we will inform the proper manufacturers. Address Readers' Information Bureau. Addresses of these companies can be found in their advertisements—see index on page 598.

<b>ADAPTERS:</b> Bakelite Corp.	<b>COILS, IMPEDANCE:</b> Dudlo Mfg. Co.	<b>CONDENSERS, VARIABLE:</b> Cardwell, Allen D. Mfg. Co. Hammarlund Mfg. Co. Karas Electric Co. National Co. United Scientific Laboratories X-L Radio Laboratories.	<b>INSULATION, MOULDED:</b> Bakelite Corp. General Plastics, Inc.
<b>AERIALS, LAMP SOCKET:</b> Dubilier Condenser Corp.	<b>COILS, INDUCTANCE:</b> Aero Products, Inc. Hammarlund Mfg. Co. Karas Electric Co. National Co.	<b>CONNECTORS:</b> Saturn Mfg. & Sales Co.	<b>JACKS:</b> Carter Radio Co. Electrad, Inc. Rono Mfg. Co. Saturn Mfg. & Sales Co. Union Radio Co.
<b>AMMETERS</b> Jewell Elec. Inst. Co.	<b>COILS, MAGNET:</b> Dudlo Mfg. Co.	<b>COPPER:</b> Copper & Brass Research Ass'n.	<b>JACKS, TIP:</b> Union Radio Co.
<b>AMPLIFIERS, RESISTANCE:</b> Allen-Bradley Co. Polymet Mfg. Co.	<b>COILS, RETARD:</b> Aero Products Co. Hammarlund Mfg. Co. Karas Electric Co.	<b>CURRENT CONTROLS, AUTO-MATIC:</b> Radiall Co.	<b>KITS, RECEIVER:</b> Donle-Bristol Corp. Equamatic System. Karas Electric Co. (Equamatic) United Scientific Laboratories. (Pierce-Aero)
<b>ARRESTERS, LIGHTNING:</b> Bakelite Corp.	<b>COILS, SHORT WAVE:</b> Aero Products Co. Hammarlund Mfg. Co.	<b>DIALS:</b> American Hard Rubber Co. Bakelite Corp. Eby, H. H. Mfg. Co. Karas Electric Co. National Co.	<b>KITS, SHORT WAVE:</b> Aero Products, Inc.
<b>BASES, VACUUM TUBE:</b> Bakelite Corp. Zierick Machine Wks.	<b>COILS, TRANSFORMER</b> Dudlo Mfg. Co.	<b>DIALS, VERNIER:</b> Karas Electric Co. National Co.	<b>KITS, TESTING:</b> Jewell Elec. Inst. Co.
<b>BATTERIES, DRY:</b> National Carbon Co.	<b>CONDENSERS, BY-PASS:</b> Deutschmann, Tobe, Co. Dubilier Condenser Corp. Polymet Mfg. Corp.	<b>ELIMINATORS, B BATTERY:</b> American Transformer Co. Dongan Elec. Mfg. Co. Modern Electric Mfg. Co. National Co. Thordarson Elec. Mfg. Co.	<b>KITS, TRANSMITTING:</b> Aero Products, Inc.
<b>BINDING POSTS:</b> Bakelite Corp. Eby, H. H. Mfg. Co. X-L Radio Labs.	<b>CONDENSERS, FILTER:</b> Deutschmann, Tobe, Co. Dubilier Condenser Corp. Polymet Mfg. Co.	<b>ELIMINATORS, UNITS FOR:</b> Dongan Elec. Mfg. Co.	<b>KNOBS:</b> Bakelite Corp.
<b>BOXES, WOODEN PACKING</b> Tift Bros.	<b>CONDENSERS, FIXED:</b> Aerovox Wireless Corp. Cardwell, Allen D. Mfg. Co. Deutschmann, Tobe, Co. Dubilier Condenser Corp. Electrad, Inc. Polymet Mfg. Corp.	<b>FILAMENT CONTROLS, AUTO-MATIC:</b> Radiall Co.	<b>LACQUER:</b> Egyptian Lacquer Co.
<b>BRACKETS, SUBPANEL:</b> Karas Electric Co.	<b>CONDENSERS, MIDGET:</b> Cardwell, Allen D. Mfg. Co. Hammarlund Mfg. Co.	<b>FOIL:</b> U. S. Foil Co.	<b>LABORATORIES:</b> Electrical Testing Labs.
<b>BRASS:</b> Copper and Brass Research Ass'n.	<b>CONDENSERS, MULTIPLE:</b> Cardwell, Allen D. Mfg. Co. General Radio Co. Hammarlund Mfg. Co. United Scientific Laboratories.	<b>GRID LEAKS:</b> Aerovox Wireless Co. Allen-Bradley Co. Dubilier Condenser Corp. Electrad, Inc. International Resistance Corp. Lynch, Arthur H. Co. Polymet Mfg. Corp.	<b>LEAD-INS:</b> Mucher, J. J.
<b>CHOKES, AUDIO FREQUENCY</b> National Co.	<b>CONDENSERS, FIXED TRANS-MITTING:</b> Dubilier Condenser Corp.	<b>HEAD SETS:</b> Bakelite Corp.	<b>LOCK WASHERS:</b> Shakeproof Lock Washer Co.
<b>CHOKES, RADIO FREQUENCY:</b> Cardwell, Allen D., Mfg. Co.	<b>CONDENSERS, VARIABLE TRANSMITTING:</b> Cardwell, Allen D. Mfg. Co. General Radio Co. Hammarlund Mfg. Co.	<b>HORNS, MOLDED:</b> Bakelite Corp.	<b>LOOPS:</b> Deutschmann, Tobe, Co.
<b>CHOKES, B ELIMINATOR:</b> American Transformer Co. Dongan Elec. Mfg. Co. General Radio Co. Modern Elec. Mfg. Co. National Co. Thordarson Elec. Mfg. Co.	<b>CONDENSERS, FIXED TRANS-MITTING:</b> Dubilier Condenser Corp.	<b>INDUCTANCES, TRANSMITTING:</b> Aero Products, Inc.	<b>LUGS:</b> Mucher, J. J. Zierick Machine Wks.
<b>CLAMPS, GROUND:</b> Mucher, J. J.	<b>CONDENSERS, VARIABLE TRANSMITTING:</b> Cardwell, Allen D. Mfg. Co. General Radio Co. Hammarlund Mfg. Co.	<b>MAGNETS, SPEAKER:</b> Bullens, D. K. Co.	<b>METERS:</b> Jewell Elec. Inst. Co.
<b>CLIPS, SPRING:</b> Mucher, J. J.		<b>MOUNTINGS, RESISTANCE:</b> Mucher, J. J.	
<b>COILS, CHOKE:</b> Dudlo Mfg. Co.			

- NUTS:**  
Shakeproof Lock Washer Co.
- PACKING MATERIALS:**  
Tift Bros.
- PANELS, COMPOSITION:**  
American Hard Rubber Co.  
Bakelite Corp.
- PANELS, METAL:**  
Crowe Nameplate Co.
- PAPER, CONE SPEAKER:**  
Seymour Co.
- PLUGS:**  
Bakelite Corp.  
Polymet Mfg. Co.  
Saturn Mfg. & Sales Co.
- POTENTIOMETERS:**  
Allen-Bradley Co.  
Electrad, Inc.  
United Scientific Laboratories.
- RESISTANCES, FIXED:**  
Aerovox Wireless Co.  
Allen-Bradley Co.  
Electrad, Inc.  
International Resistance Corp.  
Lynch, Arthur H. Co.  
Polymet Mfg. Corp.
- RESISTANCES, VARIABLE:**  
Allen-Bradley Co.  
American Mechanical Labs.  
Central Radio Labs.  
Electrad, Inc.  
International Resistance Corp.  
Polymet Mfg. Corp.
- RHEOSTATS:**  
Allen-Bradley Co.  
Carter Radio Co.  
Polymet Mfg. Corp.  
United Scientific Laboratories.
- SETS, RECEIVING:**  
United Scientific Laboratories.
- SHIELDING, METAL:**  
Copper and Brass Research Assn.  
Crowe Nameplate Co.  
Zierick Machine Wks.
- SOCKETS, TUBE:**  
Bakelite Corp.  
Eby, H. H. Mfg. Co.  
Karas Electric Co.  
Saturn Mfg. & Sales Co.
- SOLDER:**  
Chicago Solder Co. (Kester).
- SPEAKERS:**  
Amplion Corp. of America.
- STAMPINGS, METAL:**  
Mucher, J. J.  
Zierick Machine Wks.
- STRIPS, BINDING POST:**  
Mucher, J. J.  
X-L Radio Laboratories.
- SUBPANELS:**  
Amer. Hard Rubber Co.  
Bakelite Co.
- SWITCHES**  
Carter Radio Co.  
Rono Mfg. Co.  
Saturn Mfg. & Sales Co.
- TESTING INSTRUMENTS:**  
Jewell Elec. Inst. Co.
- TESTING KITS:**  
Jewell Elec. Inst. Co.
- TESTING LABORATORIES:**  
Electrical Testing Labs.
- TRANSFORMERS, AUDIO:**  
American Transformer Co.  
Dongan Elec. Mfg. Co.  
Karas Elec. Co.  
Modern Elec. Mfg. Co.  
Robertson-Davis Co.  
Thordarson Elec. Mfg. Co.  
Walker, Geo. W. Co.
- TRANSFORMERS, B-ELIMINATOR:**  
Dongan Elec. Mfg. Co.
- TRANSFORMERS, FILAMENT HEATING:**  
Dongan Elec. Mfg. Co.
- TRANSFORMERS, OUTPUT:**  
Dongan Elec. Mfg. Co.
- TRANSFORMERS, POWER:**  
American Transformer Co.  
Dongan Elec. Mfg. Co.  
National Co.  
Robertson-Davis Co.  
Thordarson Elec. Mfg. Co.
- TRANSFORMERS, R. F., TUNED:**  
Cardwell, Allen D. Mfg. Co.
- TRANSFORMERS, R. F., UNTUNED:**  
Dubiller Condenser Corp.
- TUBES:**  
Donle-Bristol Corp.
- UNITS, SPEAKER:**  
Amplion Corp. of America.
- VOLTMETERS:**  
Jewell Elec. Inst. Co.
- WASHERS:**  
Shakeproof Lock Washer Co.
- WIRE, ANTENNA**  
Dudlo Mfg. Corp.  
Roebbing, J. A., Sons, Co.
- WIRE, BARE COPPER:**  
Dudlo Mfg. Co.  
Roebbing, J. A., Sons, Co.
- WIRE, COTTON COVERED:**  
Dudlo Mfg. Corp.
- WIRE, ENAMELED COPPER:**  
Dudlo Mfg. Corp.
- WIRE, LITZENDRAHT:**  
Dudlo Mfg. Corp.
- WIRE, PIGTAIL:**  
Dudlo Mfg. Corp.
- WIRE, SILK COVERED:**  
Dudlo Mfg. Corp.
- WIRE, TINNED COPPER:**  
Dudlo Mfg. Corp.  
Roebbing, J. A., Sons, Co.

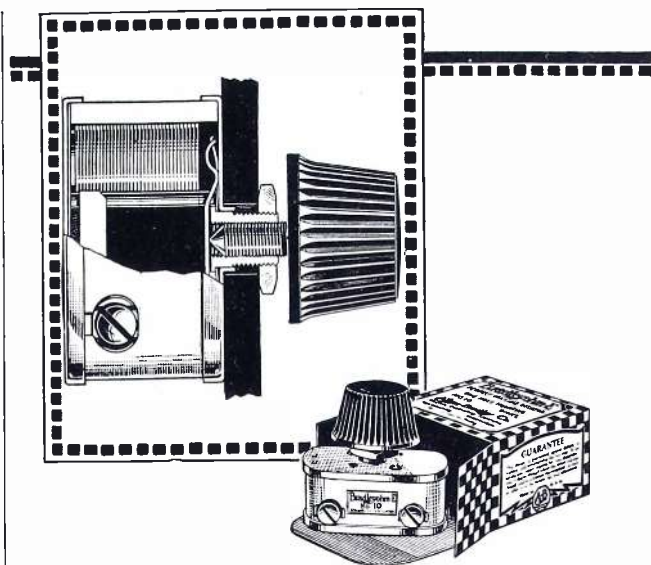

## Use Allen-Bradley Resistors for B-Eliminator Hook-Ups

THE success of a B-Eliminator hookup depends as much on the operation of the variable and fixed resistors as it does on the type of circuit used. Allen-Bradley variable and fixed resistors lead the field for this service. Use them in your B-Eliminator hookup.

# Bradleyohm-E

### PERFECT VARIABLE RESISTOR

This new oversize resistor is used as standard equipment by leading B-Eliminator manufacturers such as Acme, All-American, Majestic, Philadelphia Storage Battery, and Willard. It is the ideal variable resistor for controlling plate voltage output. The scientifically treated discs in Bradleyohm-E provide stepless, noiseless, plate voltage control, and the setting will be maintained indefinitely. Do not experiment with makeshift variable resistors, when Bradleyohm-E has been pronounced the ideal unit by the largest manufacturers of B-Eliminators in the world. Ask your dealer for Bradleyohm-E when you build your B-Eliminator.



## Bradleyunit-A

**PERFECT FIXED RESISTOR**  
Another triumph of the Allen-Bradley Research Laboratory is Bradleyunit-A, a perfect fixed resistor that contains no glass, requires no hermetic sealing, and can be soldered into place without the use of clip mountings. Bradleyunit-A is not affected by temperature or moisture and it maintains its calibration indefinitely.

**MAIL  
THE  
COUPON**

**ALLEN-BRADLEY COMPANY,**  
288 Greenfield Ave., Milwaukee, Wis.

Please send me your literature on Allen-Bradley radio devices and B-Eliminator hookups.

Name .....

Address .....

# Chosen by EXPERTS

GLENN H. BROWNING, Laurence M. Cockaday, Gerald M. Best and many other eminent radio designers use the Lynch Metallized Resistor in their experimental circuits and receivers. These men know radio; they have laboratory and testing equipment with which quickly to make accurate comparisons. There could be no better proof of the true merit of the Lynch Metallized Resistor than the endorsement of these experts.

Comprising a concentrated metallized deposit one-thousandth of an inch thick upon a rigid core, sealed forever within a glass tube, the Lynch Metallized Resistor gives *conductive, non-arcing* resistance that remains silent, accurate!

Dealers—Write us!

ARTHUR H. LYNCH, Inc.  
Fisk Bldg., Broadway & 57th Street  
New York, N.Y.

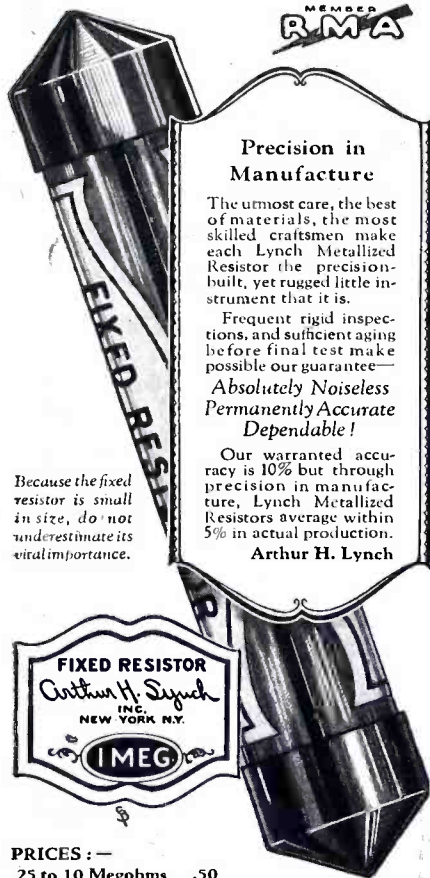

### Precision in Manufacture

The utmost care, the best of materials, the most skilled craftsmen make each Lynch Metallized Resistor the precision-built, yet rugged little instrument that it is.

Frequent rigid inspections, and sufficient aging before final test make possible our guarantee—

**Absolutely Noiseless  
Permanently Accurate  
Dependable!**

Our warranted accuracy is 10% but through precision in manufacture, Lynch Metallized Resistors average within 5% in actual production.

Arthur H. Lynch

Because the fixed resistor is small in size, do not underestimate its vital importance.

#### PRICES:—

.25 to 10 Megohms	.50	Single Mounting	.35
above .01 to .24 "	.75	Double	.50
.001 to .01	\$1.00		

Lynch Metallized Resistors cost no more than the ordinary kind. If your dealer cannot supply you it will be well worth your while to wait for the mail—we ship post-paid, at once.

# LYNCH METALLIZED

## FIXED RESISTORS

## To the Technical Men Employed by Dealers and Jobbers

Are you keeping up with new designs that are most popular with the set builders?

Do you follow new trends which effect the requirements of complete set customers?

Have you got on hand all the latest dope on the sets that are most widely discussed?

Very likely you are missing a lot of these things if you do not read **RADIO MECHANICS** each month.

Just as **RADIO ENGINEERING** interprets the technical developments to you, **RADIO MECHANICS**, now the second largest popular radio magazine will bring you the latest news of things of interest to your customers.

SEND THIS COUPON  
NO MONEY NECESSARY.

Radio Mechanics, Inc.  
Radio Hill,  
Poughkeepsie, N. Y.

Enter my subscription to Radio Mechanics, starting with the ..... issue. I will send you my check or money order for \$2.00 upon receipt of the first issue.

Name .....

Street .....

City .....

State .....

Position .....

.....

## INDEX OF ADVERTISERS

	PAGE
A	
Aero Products, Inc.....	641
Aerovox Wireless Corp.....	639
Allen-Bradley .....	645
American Hard Rubber Co.....	606
American Mechanical Labs.....	634
American Transformer Co..	Back Cover
Amplion Corp. of America.....	639
B	
Bakelite Corp.....	629
C	
Cardwell, Allen D., Mfg. Corp....	642
Central Radio Labs.....	647
Chicago Solder Co.....	640
Copper & Brass Research Ass'n..	639
Crowe Mfg. Co.....	605
D	
Dongan Elec. Mfg. Co., Inside Back Cover	
Donle-Bristol Corp.....	640
Dubilier Condenser & Radio Corp.	608
Dudlo Mfg. Corp.....	604
E	
Eby, H. H. Mfg. Co.....	640
Egyptian Lacquer Co.....	642
Electrad, Inc.....	643
Electrical Testing Labs.....	642
Equamatic System.....	607
G	
General Radio Co.....	593
H	
Hammarlund Mfg. Co. Inside Front Cover	
Hotel Pennsylvania.....	643
I	
International Resistance Co.....	640
J	
Jewell Elec. Inst. Co.....	631
K	
Karas Electric Company.....	648
L	
Lynch, Arthur H.....	646
M	
Modern Electric Co.....	603
Mucher, John J.....	642
N	
National Carbon Co.....	607
P	
Polymet Mfg. Corp.....	641
R	
Radiall Corp.....	642
Robertson-Davis Co.....	647
Roebling, J. A. Son's Co.....	642
Rono Mfg. Co.....	639
S	
Seymour Paper Co.....	647
Shakeproof Lock Washer Co.....	635
T	
Thordarson Elec. Co.....	633
Tift Bros.....	635
Tobe Deutschmann Co.....	637
U	
Union Radio Corp.....	637
United Scientific Labs.....	638
W	
Walker, Geo. W., Co.....	643
X	
X-L Radio Labs.....	642
Z	
Zierick, F. R.....	642

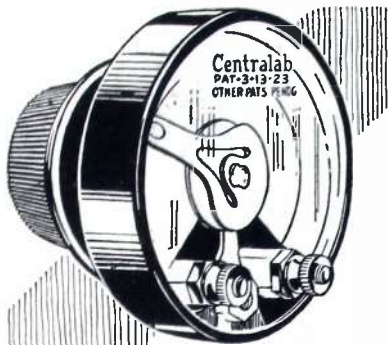

CENTRALAB  
RADIOHM

## Centralab Products

Radiolins, Modulators and Potentiometers sell at

\$2 each

Switch Type Radiolins at \$2.30

Are specified for many of the most popular of the season's Radio Circuits including Varion, Infradyne, Henry Lyford, Bruno, Improved Browning-Drake, and as voltage or C-bias controls in many of the new power packs including AmerTran.

This is merchandise that you can profitably recommend to your customers; it is fully guaranteed to give satisfaction.

**CENTRAL RADIO LABORATORIES**  
25 Keefe Avenue, Milwaukee, Wis.

CENTRALAB Modu Plugs, standard or cord type, at \$2.50



# ALHAMBRA



Patented U. S. June 20, 1911; France, May 4, 1911; Great Britain, May 11, 1911; Canada, Aug. 15, 1911. Other Foreign Patents Pending.

**Alhambra Cone Speaker Paper is used exclusively by 90% of the cone speaker manufacturers**

ALHAMBRA PAPER is a scientific development which brings out true tone reproduction. It has no grain, hence no resonance point of its own; it resonates uniformly at all frequencies.

ALHAMBRA is furnished in sheets suitable for cone speakers of 13 inches to 36 inches diameter. Special sizes to order.

**ALHAMBRA CONE SPEAKERS HAVE MADE ALL OTHER TYPES OBSOLETE**

*Speaker Manufacturers please communicate.*

**The SEYMOUR Co.**

Sole Distributors for U. S. A. and Export

323 W. 16th St.

New York City



The famous

## Melo-Heald Eleven Circuit

DESCRIBED BY MR. HOLLIS de NEEFE IN THIS ISSUE OF RADIO ENGINEERING AND ALSO IN THE SPRING 1927 CITIZEN'S RADIO CALL BOOK

is built with Certified

**Meloformers and Melocouplers**



The Certified Meloformer is a special *alloy-core* audio frequency transformer that successfully renders three stages of ideal audio without the usual doctoring with by-pass condensers or resistors, and also provides beautiful reproduction without slightest distortion on as high as four stages. Every Meloformer is exactly the same—no kits. No matter how and when purchased—all are the same. The Meloformer stabilizes impedance, prevents leakage, and eliminates inter-stage coupling troubles.

**RADIO LABORATORIES**—Louisville, Ky., write 11/30/26. "Selectivity, tone and distance getting powers far superior to anything built heretofore. Have built practically every set, more and less expensive but never able to get same wonderful results except with the Melo-Heald famous eleven."

The great success of receivers built with Meloformers and Melocouplers is indicated by the numerous large magazines and daily newspapers that have written about them free and unsolicited.

The Certified Melocouplers are a superior type of radio frequency transformer, built with an *air-core*, for specific service in high-powered construction, that do not depend upon a freak circuit to perform at highest efficiency. Melocouplers are provided in three styles: 135 R.F., 120 R.F., and 160 R.F., each peaked, wound and tested at the same point of efficiency, making kits unnecessary. Buy them any place, any time, separately or together.

Though five intermediate transformers used, no sacrifice in amplification per stage, every builder of circuit reports.

Get all the facts today, free.

MAIL THE

COUPON

RECEIVING SET MANUFACTURERS, NOTE—A Solution for your Audio Frequency Problem! Meloformers are made in a *stripped* Manufacturer's Type at a low price for quantity purchase. Same efficiency as retail type. Now in use by many large, prominent manufacturers! FREE SAMPLE & QUOTATIONS ON REQUESTS WRITTEN ON COMPANY LETTERHEAD.

Mail Coupon or Write Today

**ROBERTSON-DAVIS COMPANY, INC.,**

(Engineers & Manufacturers of Electrical Windings)

412 Orleans St.

Dept. RE-3

Chicago, U. S. A.

District Representatives:

A. C. Lopez Co., 40 West 33rd St., New York, N. Y.  
L. M. Church & Son, 300 Eleventh St., S. W., Washington, D. C.  
Pacific Hoopler Sales Co., 1547 West Pico St., Los Angeles, Calif.  
Southern Sales, Incorporated, 2030 Dryades St., New Orleans, La.

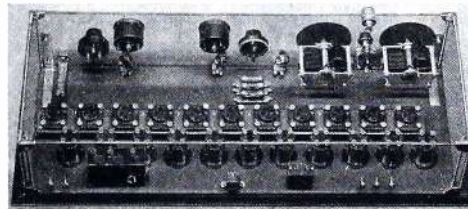

**FILL IN AND MAIL THIS COUPON TODAY FOR BLUE PRINT AND PLANS FREE**  
--- Robertson-Davis Co., Inc., 412 Orleans St., Chicago, U. S. A. ---  
Gentlemen: Please send me Full Size Blue Print Plans and Specifications of the Melo-Heald Eleven Circuit described in this issue of RADIO ENGINEERING, and also further particulars of Certified Meloformers and Melocouplers, manufactured by you, and which were used at Radio Hill in building their receiver. This is to be sent FREE and without obligation.  
Name ..... (Write or Print Clearly)  
Address .....  
City .....  
State .....  
RE-3





## Karas Harmoniks Specified for the VICTOREEN. WHY?

**V**ICTOREEN specifies Karas Harmonik Audio Frequency Amplifying Transformers for the Victoreen Superheterodyne described and illustrated in this issue of Radio Engineering. Victoreen might have specified any one of a dozen makes of audio transformers. Why did the originators of this deservedly popular super choose the Karas Harmonik FROM ALL OTHERS when writing the specifications for this set? The answer to this question lies in Victoreen's meticulously careful study of the qualities of every audio transformer—in their analysis of the characteristics of each—and in their exact knowledge of what an audio transformer must accomplish to maintain the unusually high quality of reception developed in the radio frequency and detector stages.

### Matchless Tone Quality

One of the reasons why Karas Harmoniks were chosen for the Victoreen is found in the three words *matchless tone quality*. You will agree that tone quality and amplification are the two basic requirements of any audio transformer. Victoreen learned after scores of tests of all transformers that Karas Harmoniks differ from others in possessing the ability to amplify **EQUALLY** all of the essential harmonics and pure, clear, rich overtones that combine to make up what we know as musical sounds and to match and accommodate the Victoreen detector output. The **PURITY OF TONE** of Karas Harmoniks is known throughout the world. No other transformer made offers this tonal purity in such pleasing volume as Karas Harmoniks. The Victoreen thus is able to pour forth a clean-cut, pure, sweet, distinct volume of tone that has all of the original qualities of the studio program—mellow, rich and natural.

### Tremendous Volume

The volume of tone from the Victoreen is proverbial—and Karas Harmoniks are in large measure responsible for this. It is a fact that Harmoniks deliver more amplification with their low ratio than cheap, ordinary transformers deliver with high ratios, due to the correct Karas principle of a controlled air gap which insures high amplification of low frequency, volume-carrying fundamental harmonics. While the volume of tone is tremendous in the Victoreen or in any other super or circuit where Karas Harmoniks are used, this volume is entirely without distortion because Harmoniks amplify all sounds and all harmonics and overtones of all sounds nearly equally. Being of high inductance and low distributed capacity Karas Harmoniks produce a full amplification of all high audio frequency harmonics and overtones.

### Absolute Freedom from Distortion

You have only to listen to the tone quality of an efficient super like the Victoreen to understand that here is amplification minus all distortion. No muffling—no fuzzy, indistinct words or sounds—no unnatural

reproduction—just clear, pure, sweet and full-rounded amplification of the highest quality.

### Precision Manufacture

We make Karas Harmoniks just a little better than seems necessary, paying particular attention to the little things which are all too often neglected by transformer manufacturers. On our coils you will find many thousands of turns of wire, the diameter of the wire being about the thickness of human hair. We use extremely large coils, to insure a very high inductance, and we place these coils over large iron cores to offer an easy path for the lines of magnetic force. Karas Harmoniks also have a very high impedance and very low distributed capacity. They are scientifically shielded, perfectly matched. In appearance as well as in design they are the finest transformers that can be built.

### Order Harmoniks TODAY for your Victoreen

You can secure Karas Harmoniks for your Victoreen from your nearest dealer. If he happens to be out of stock and you are in a hurry you may order two Harmoniks direct from us by filling out and mailing the coupon below. **SEND NO MONEY**. Just hand the postman the price of the transformers, plus postage, upon delivery. As Harmoniks are **SPECIFIED** for the Victoreen, you *must* use them to insure the best results of which this great super is capable, so order them today.

### KARAS ELECTRIC CO.

1093 Association Building, Chicago

KARAS ELECTRIC CO.  
1093 Association Bldg., Chicago  
Please send me 2 Karas Harmonik Audio Transformers for my Victoreen, price \$7 each, for which I will hand the postman \$14 plus postage upon delivery.

Name .....

Address .....

City ..... State .....

(If cash accompanies your order, we prepay postage.)



## Engineering and Mass Production

Those two features are important to you, the manufacturers of sets and eliminators.

Dongan's reputation for being a step ahead in transformer design and a large factory devoted entirely to the production of parts has placed Dongan transformers and chokes as standard equipment in many leading sets and battery-eliminators.

As a source of supply you will find the utmost in cooperation in the Dongan organization.

No. 147 Out Put Transformer designed for use in connection with the output circuit. Avoids the loss of B. voltage due to high resistance of the

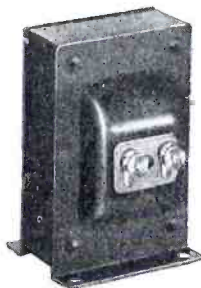

loud speaker and eliminates all risk of damage to the speaker. See your dealer or send money-order to factory direct.

**DONGAN ELECTRIC MANUFACTURING COMPANY**

2995-3001 Franklin St.

DETROIT, MICHIGAN

**TRANSFORMERS of MERIT for FIFTEEN YEARS**

# AN EXPLANATION OF AMERTRAN DE LUXE EFFICIENCY

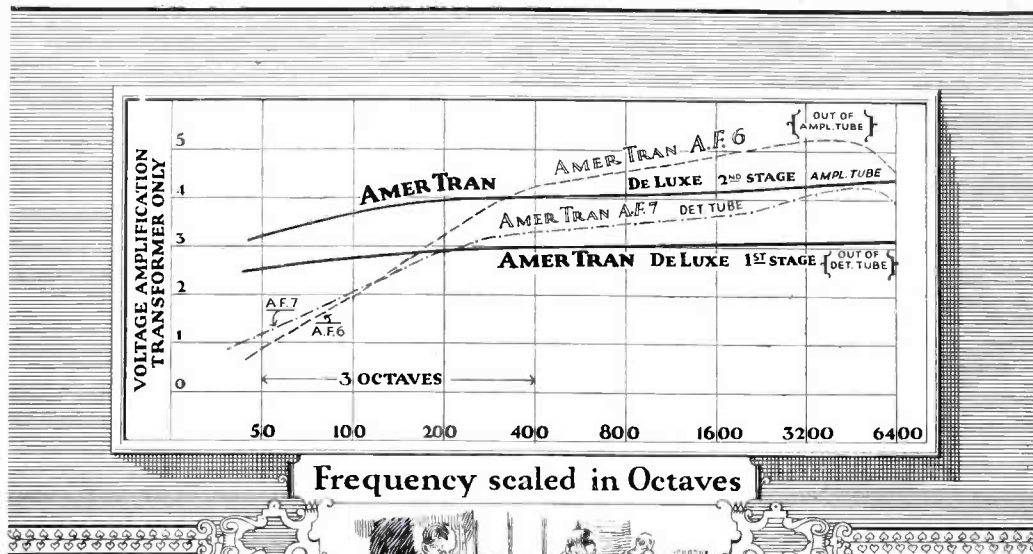

Frequency scaled in Octaves



The above curves are plotted from measurements made in accordance with the latest tentative rules of the N. E. M. A. These curves have been proven conservative, and accurately represent the AmerTran DeLuxe Audio transformer.

For one and one-half years the AmerTran DeLuxe has been used with great success by all those seeking improved audio amplification. The secret of its excellence centers chiefly in the special alloy core material which provides the high inductance needed for the normal amplification of the fundamental base tones. This makes possible an improved coil structure for maintaining the higher frequencies with no appreciable "peak" or "droop" until beyond the useful range.

There is a remarkable absence of the muffling of sibilant sounds and "background"—often noticeable with transformers having "drooping" characteristics.

The AmerTran DeLuxe is well made and designed to give long, dependable service. Metal cased and embedded in a solid compound, it is not affected by climatic changes.

The better reception obtained by installing correctly a pair of AmerTrans is final proof of their efficiency rating.

## THE AMERICAN TRANSFORMER CO.

178 Emmet Street

Transformer Builders for Over 26 Years

Newark, N. J.

Write for free booklet, entitled "Improving the Audio Amplifier," together with other technical data.

The AmerTran De Luxe made in two types for first and second stages. \$10.00 Each.



### Other AmerTran Products

AmerTran Power Transformer Type PF52 \$18.00 Each.  
 AmerChoke Type 854 \$6.00 Each.  
 AmerTran Audio Transformers Types AF7 and AF6 \$5.00 Each.